

SAUNA ASSEMBLY INSTRUCTIONS (PAGE 11-23)

REQUIREMENTS:

2 People (Recommended)
Rubber Mallet
Carpenter Level
Carpenter Square
Tape Measure
Silicone
Sand Paper
Clamp

Nail Gun
Cordless Drill
Drill Bit set
Step Ladder
Utility Knife
Wood Glue
Wood Putty

Step 1: Base Assembly

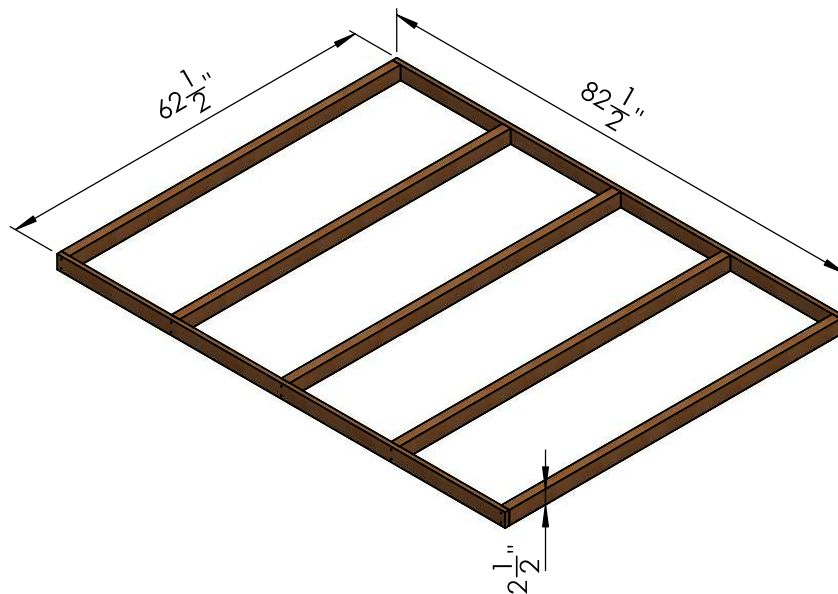

-Locate the 2x3 joists to provided pre drilled holes of the rim joist boards and screw from outside

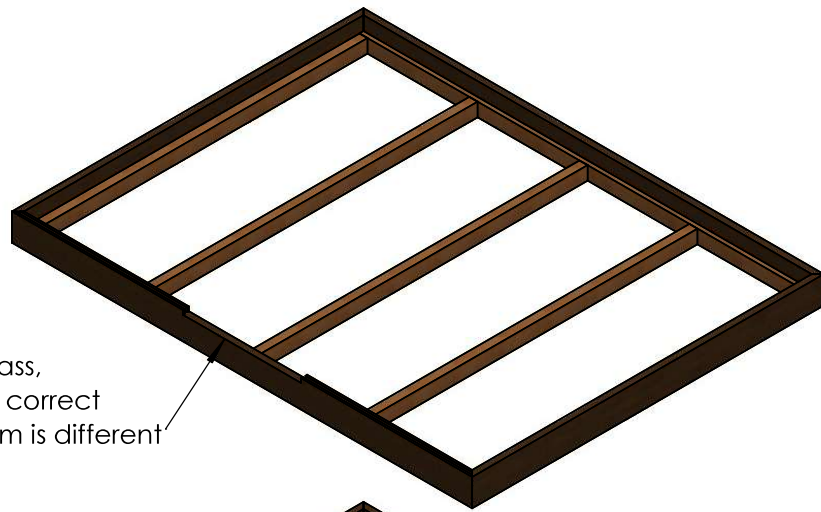

Cutout for Glass,
Be sure to use correct
board, top trim is different

- Secure floor support boards using nails from inside
- Be sure the base is square



- Gather 1x6 tongue and groove boards
- Insert the boards into the frame ensuring that they are tight by tapping them together with a rubber mallet
- Fasten the boards into the end joists with 1-1/2" screws, this screws will be hidden by framing base plate

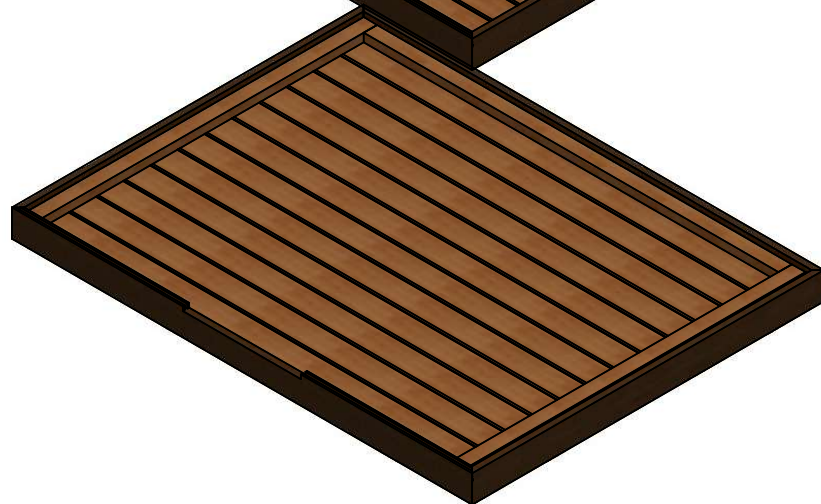

- Gather 2 side and 1 back plate
- Space them 9/16" from outer base side and back
- Attach plates to the base assembly using 2-3/4" screws
- Try to screw where joist are underneath for more secure connection

Step 2: Add Back & Side Panels to Base

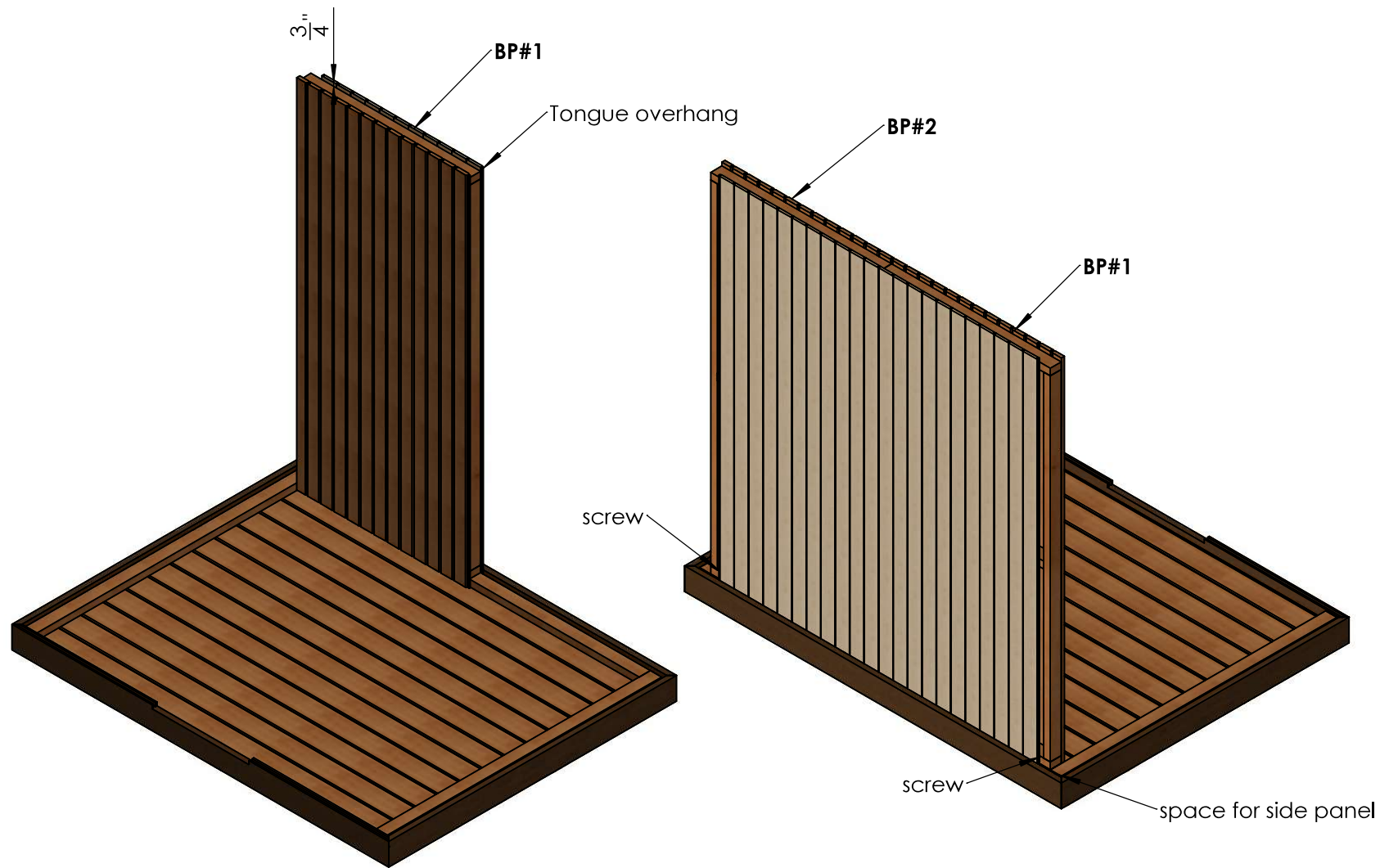

-Place the **BP#1** onto the back base plate as shown
-To keep it upright, use 2 screws to fasten it to the base plate through small space at the end

-Place the **BP#2** onto the back base plate as shown
-Use the rubber mallet to adjust, make sure space for side panel
-To keep it upright, use 2 screws to fasten it to the base plate through small space at the end

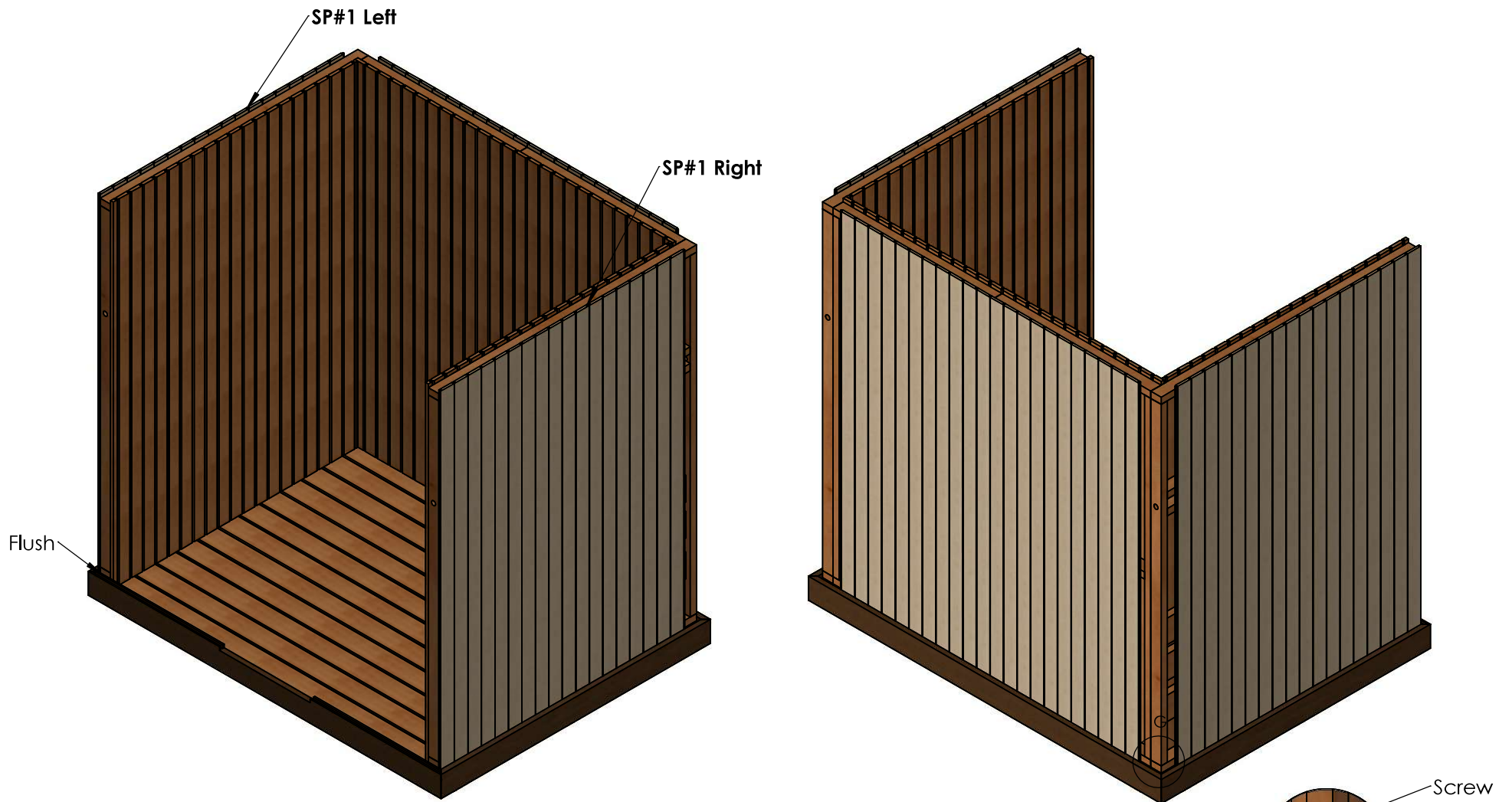

- Place the side panel **SP#1** onto the side base plate
- Use the rubber mallet to make the frames flush with base plate
- For upright strength, use 2 screws to fasten it to the base plate through small space at the end
- Screw into the back frame through the side frame at 3 places
- Repeat the process on the other side for another side panel **SP#1**

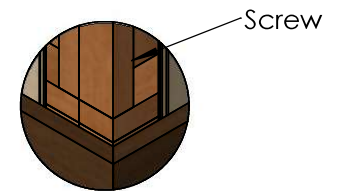

DETAIL G

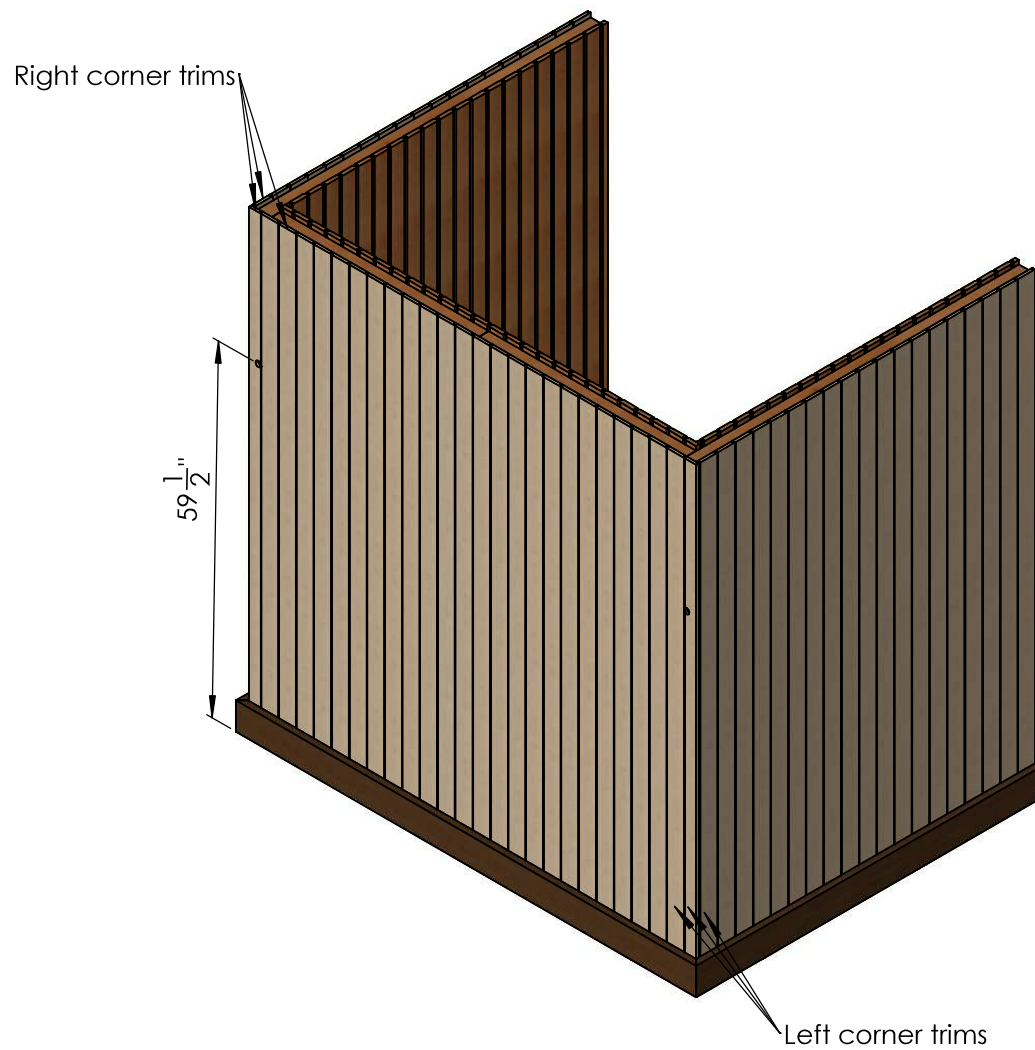

- Nail back corner trim boards to assembly as shown
- Make sure to use board with hole at the back side corner as shown, which will align to the hole of the side frame stud

Step 3: Add Wall Connectors

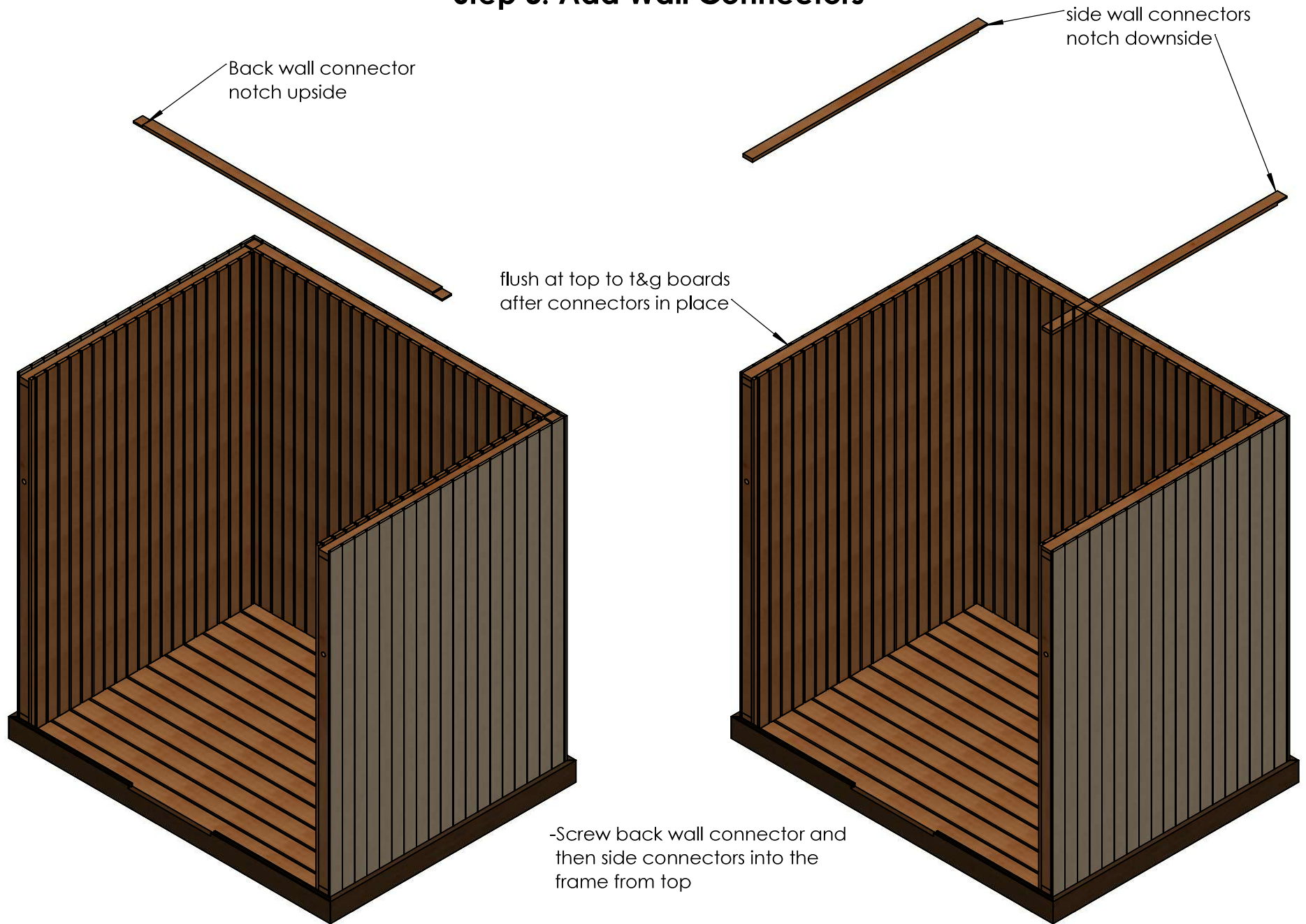

- Place the roof panel **RP#1** on the top of the sauna at the back side
- Ensure the roof panel is flush to the back and side of the sauna
- Note the orientation of the roof panel, grooves should line up with the sauna side panel's grooves
- Screw from top into the frames

- Place the roof panel **RP#2** on the top of the sauna
- Use rubber mallet to in place tongue and groove connection
- Ensure the roof panel **RP#2** is flush at the front and sides of the sauna

Step 4: Add Roof Panels

Tongue overhang to attach in grooves in next step

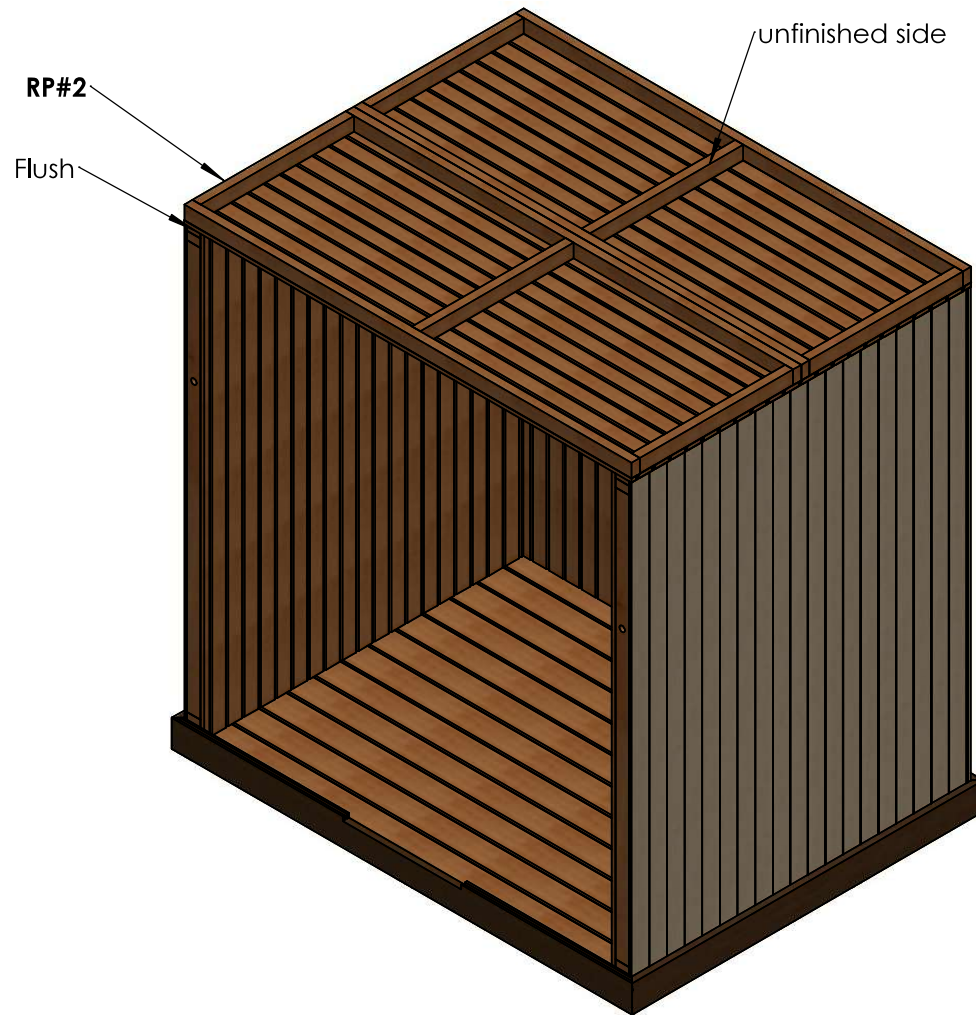
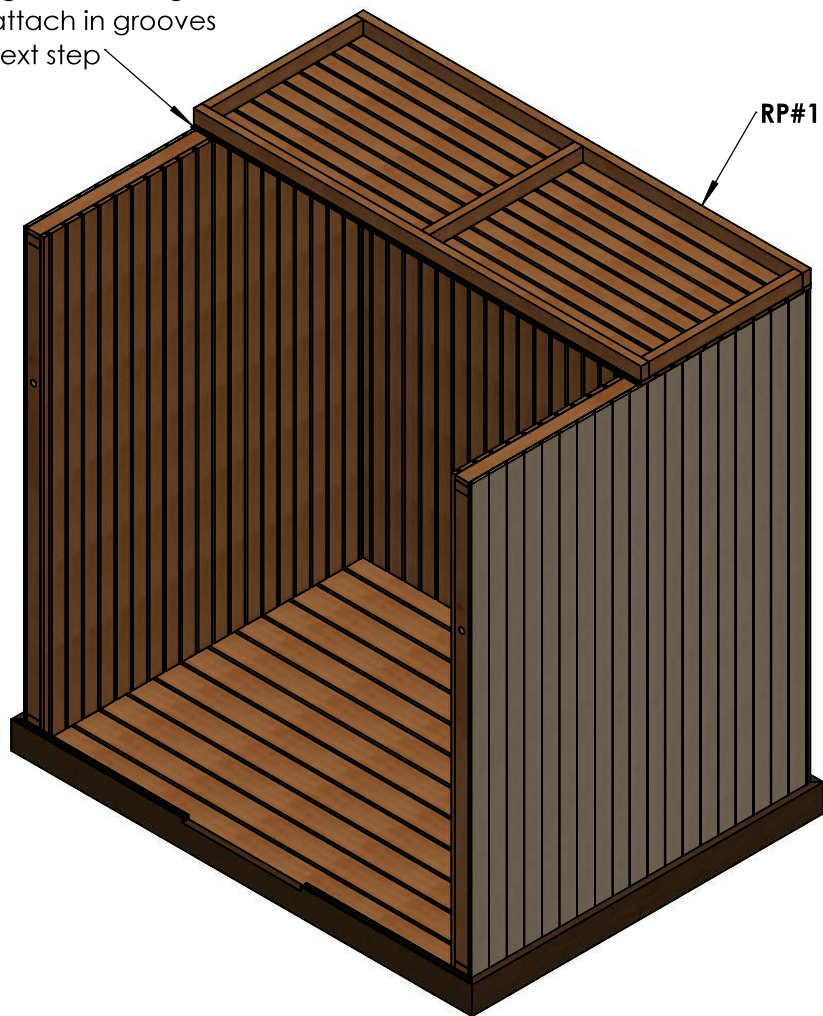

Step 5: Add Outer Trims

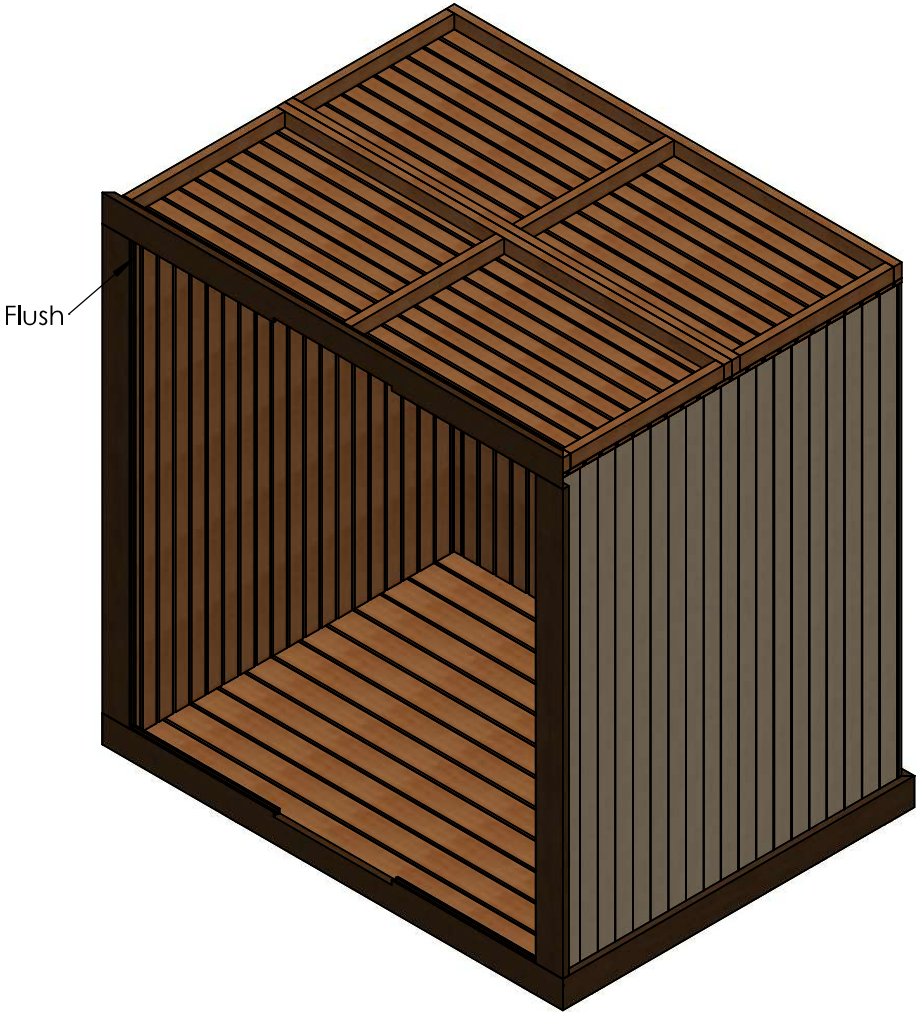

Flush

- Nail front trims to the sauna
- Use wood putty to cover nail marks

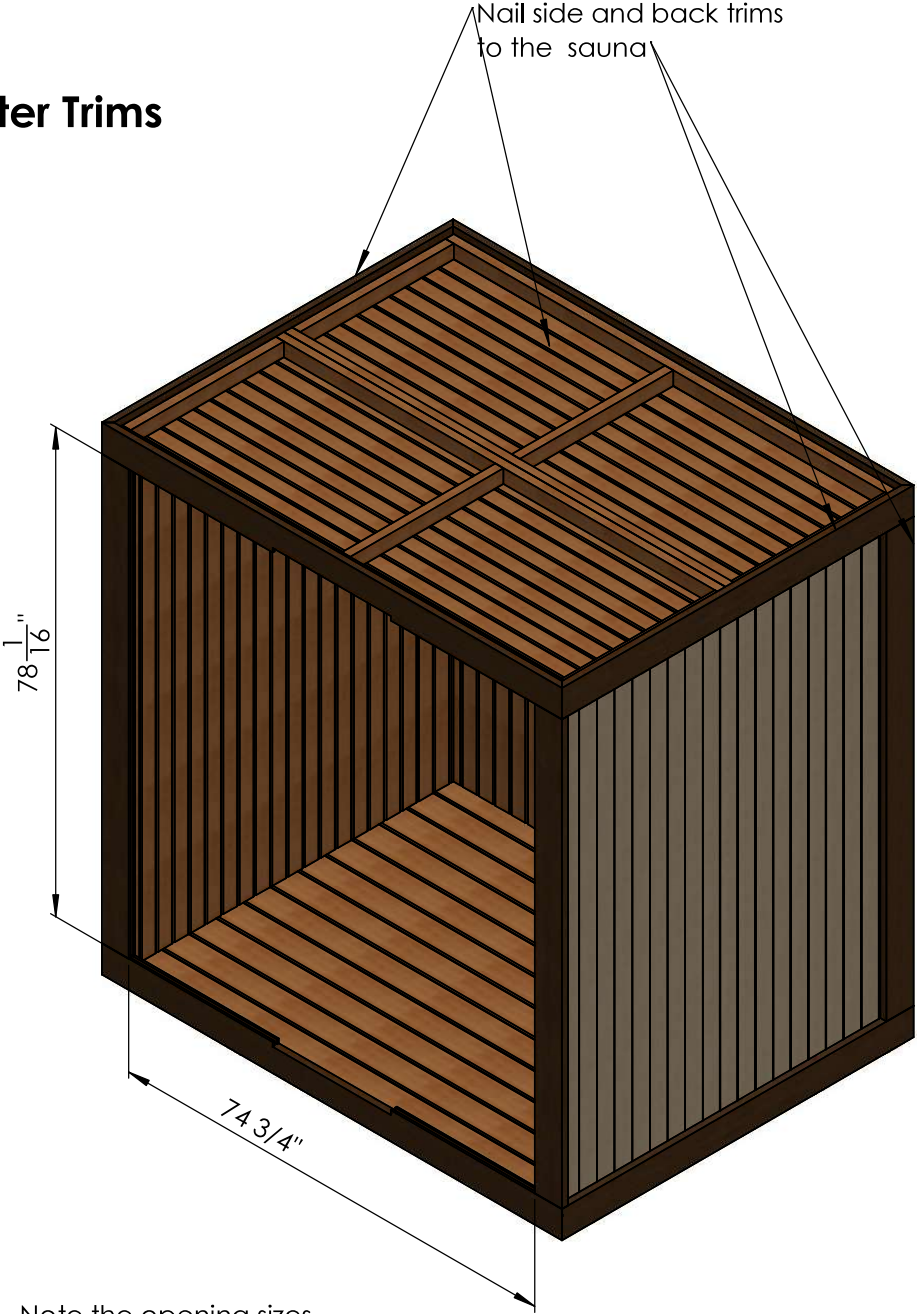

Nail side and back trims to the sauna

78 ¹/₁₆"

74 ³/₄"

- Note the opening sizes
- Make sure trims are square to fit glass panels

Step 6: Add Benches, Back Rest, Inside Trims & Heater

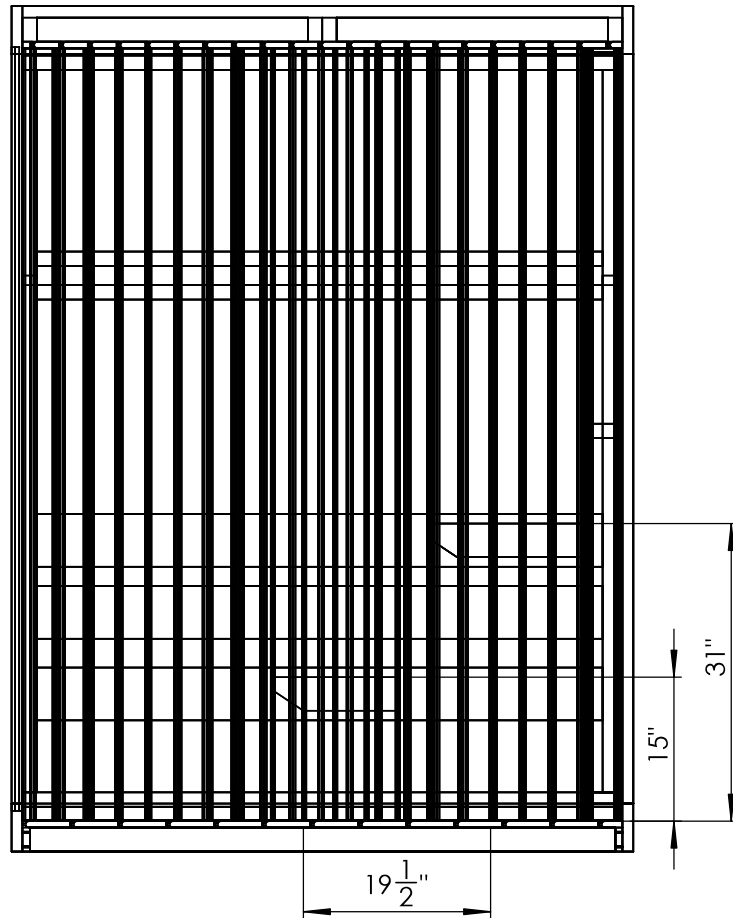

Side View- Wire Frame

- Screw upper bench supports to the sides of the sauna
- Screw lower bench support on other side of the heater
- 1x6 blocking is provided in the frame to hold them

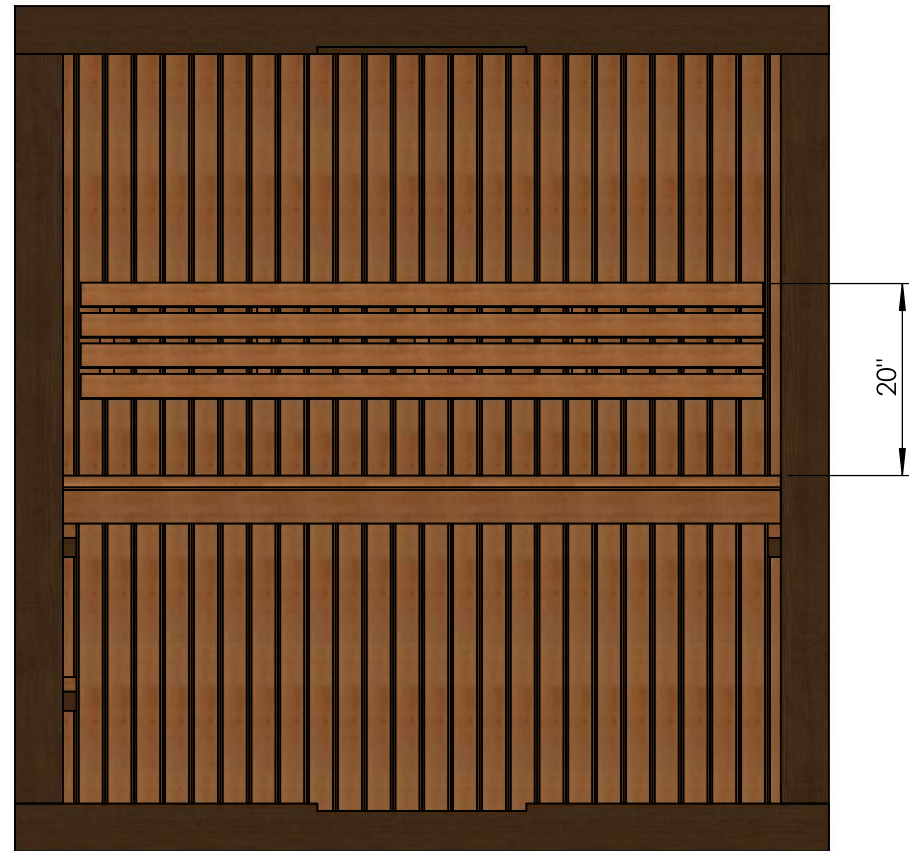

Front View

- Place the upper bench on the support installed
- Attach back rest on center of the sauna

screw in between
of slats into
side cleat

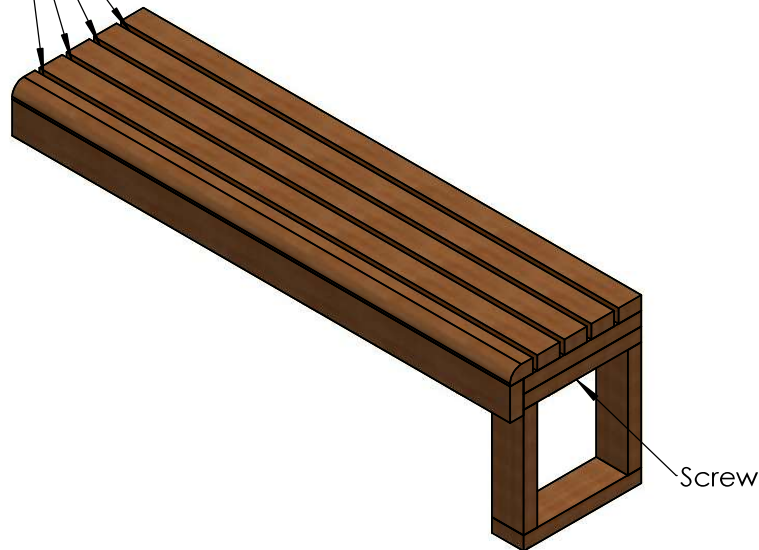

- Gather lower bench & support
- Pre drill and screw support to the bench from underside
- No visible screw

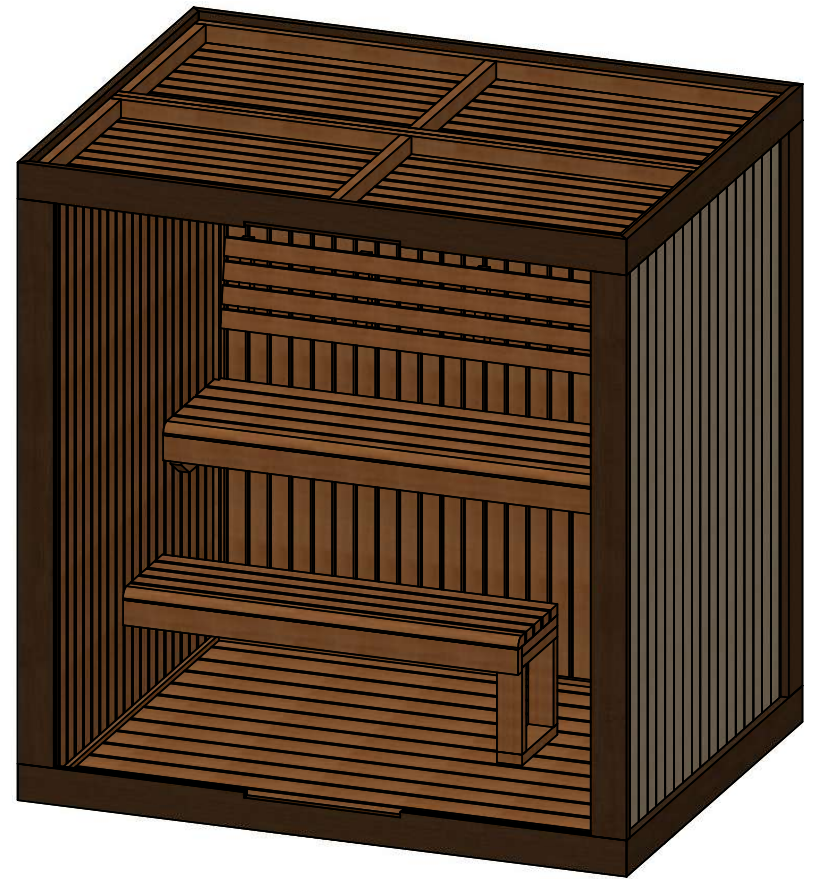

- Nail inside corner trims (to be cut to fit)

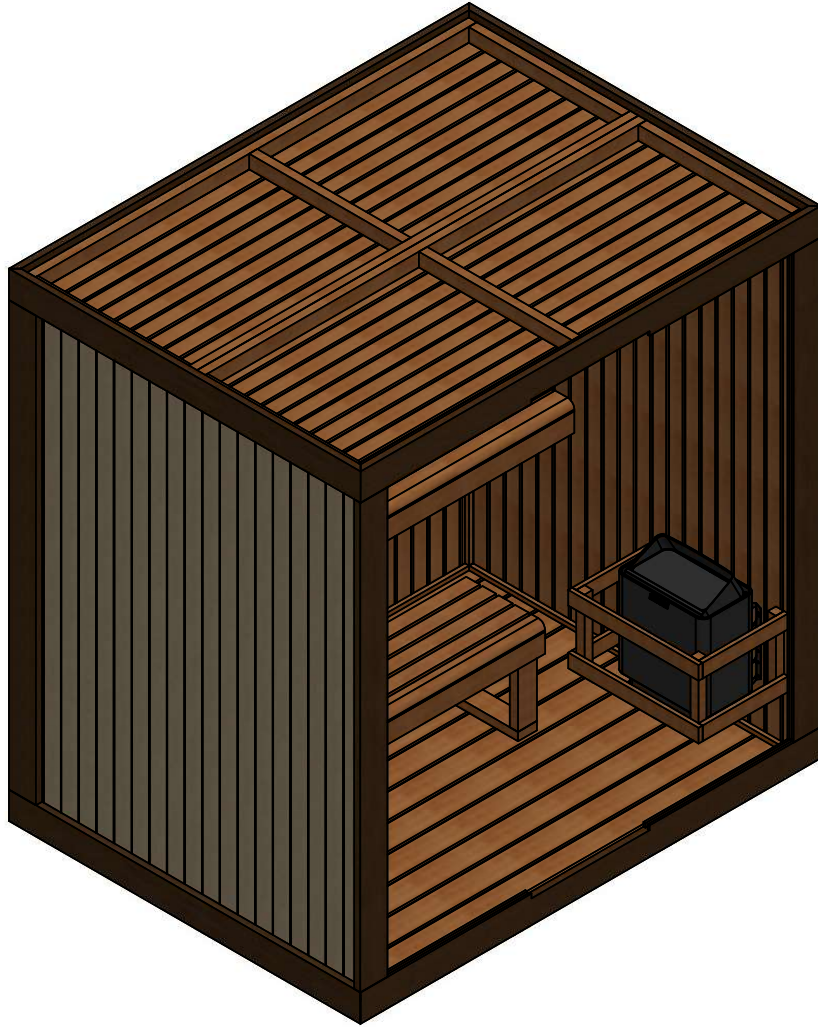

- Install the Electric Heater to the sauna
- Please follow detailed installation guide found on LeisureCraft website as per your choice of heater
- Install Heater Guard as below,
- Stand the 2 assembled side pieces of the heater guard on edge with pre-drilled holes on the bottom
- Screw heater guard support to either side using two 1-1/2" screws per side
- Repeat for the bottom heater guard support
- Place two 2-1/2" screws into the pre-drilled holes on either side of the heater guard to prepare for mounting
- Center the guard around the heater and secure to wall with the preplaced screws
- Ensure the guard is level and secure the other side

Step 7: Add Doors, Hardwares & Heater

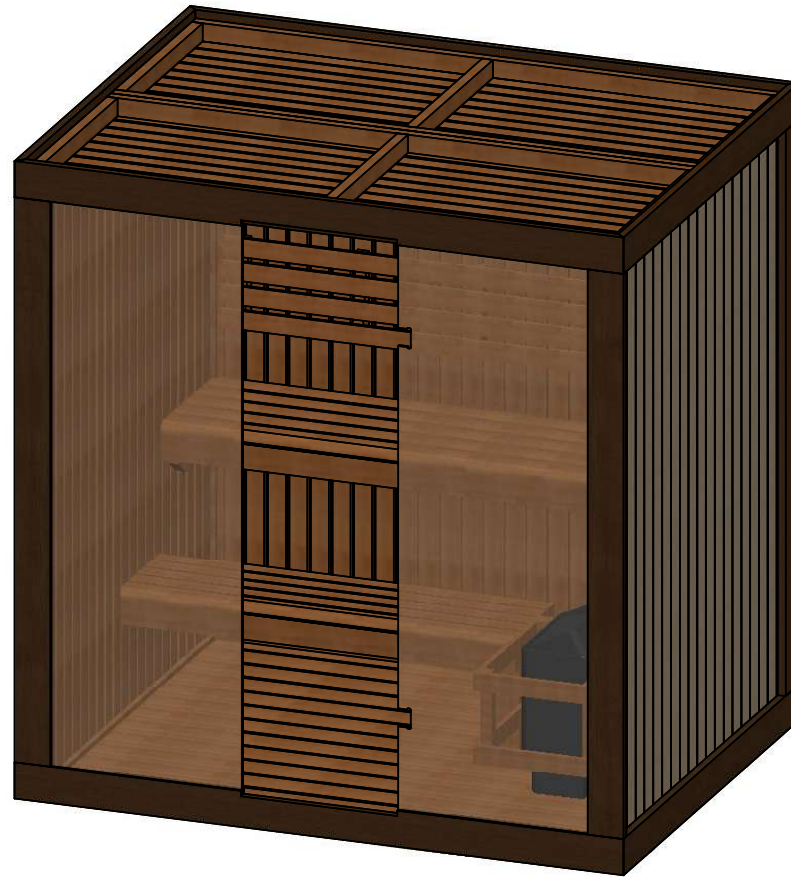

- Apply small silicone bead inside the grooves of the trims if needed
- Slide the fixed glass panels into the grooves of the outer trims

- Install hinges first on the fixed door side, with the screw heads facing toward the sauna interior, remove the interior metal pieces of the hinges
- Be sure to inplace rubber gaskets in between and they should not be visible, screw in from inside
- Remove the interior metal pieces of the other side of the hinge and inplace the gaskets
- Place the door to the hinges and gaskets, use wood shims support to adjust the height
- Place the interior gaskets on the glass and re-attach the interior hinge piece, tighten the screws
- Check the glass spacing for any contact or binding
- Adjust the door hinge adjustment screws if needed, Glass door should stop on the back part of the trims
- Gather the door handle parts, add the gasket and inplace the screw from inside
- Add Rubber Sweep to the glass door

