



# ASSEMBLY INSTRUCTIONS

for

# TRANQUILITY SAUNA

Read these assembly instructions and the accompanying video to enhance your building experience.



[www.leisurecraft.com](http://www.leisurecraft.com)

Other fine products by Leisure Craft



# Table of Contents

TOOLS CHECKLIST	Pg 4
SAUNA BASE PREPARATION	Pg 5
BOTTOM FRAME assembly	Pg 6-10
FRONT & REAR WALL assembly	Pg 11-15
CURVED WALL assembly	Pg 16-17
STAVES TOO LOOSE	Pg 18-19
STAVES TOO TIGHT	Pg 19-20
STEEL BAND assembly	Pg 21-26
FLOOR assembly & installation	Pg 27-29
BENCH assembly & installation	Pg 30-31
DOOR HANDLE installation	Pg 32-33
OUTSIDE BENCH installation	Pg 34-37
SHINGLE installation	Pg 38-47
VENT installation	Pg 48-51
METAL ROOF Installation	Pg 52-56
ACCESSORY Install Section	Pg 57-58
Maintaining Your Sauna	Pg 60
Warranty	Pg 63

# CONGRATULATIONS

## on the purchase of your Canadian Timber TRANQUILITY Sauna

**Just a few things to follow.....**

**Please be sure to read this entire manual  
Before proceeding with the assembly.**

All electrical connections must be performed  
By a qualified electrician.



For further information about your heater and  
Installation instructions, please refer to the  
provided heater manual.



Always ensure that you have the correct screw  
length so that the screw does not go all the way  
through the material and come out the other side.



# TOOLS CHECKLIST

Ensure you have the following tools to finish the job right!



Cordless Driver

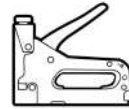

Staple Gun



Nail Gun



Utility Knife



Hammer



Tape Measure

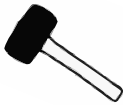

Mallet



Marker or Pencil



Level



**3/4" (19 mm) Socket**



**1/4" (6 mm) Socket**



**#3 Robertson Bit (Short bit + 4" or longer)**



**2" (51 mm) Hole Saw with bit for cordless driver or drill. 1 1/2"- 2" (38-51 mm) size**

# SAUNA BASE PREPARATION

Ensure the base for your sauna is level with a slight slope to the back for drainage. A solid base for your sauna is recommended and can be made from the following.

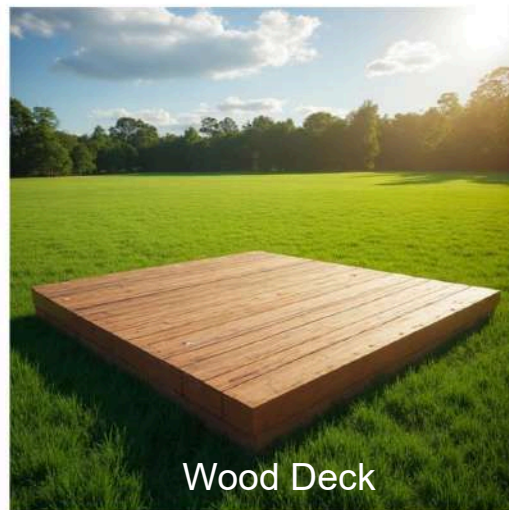

It is recommended to build a base larger than required to provide a sitting area for cooling off during your sauna session.

# ASSEMBLY INSTRUCTIONS

1

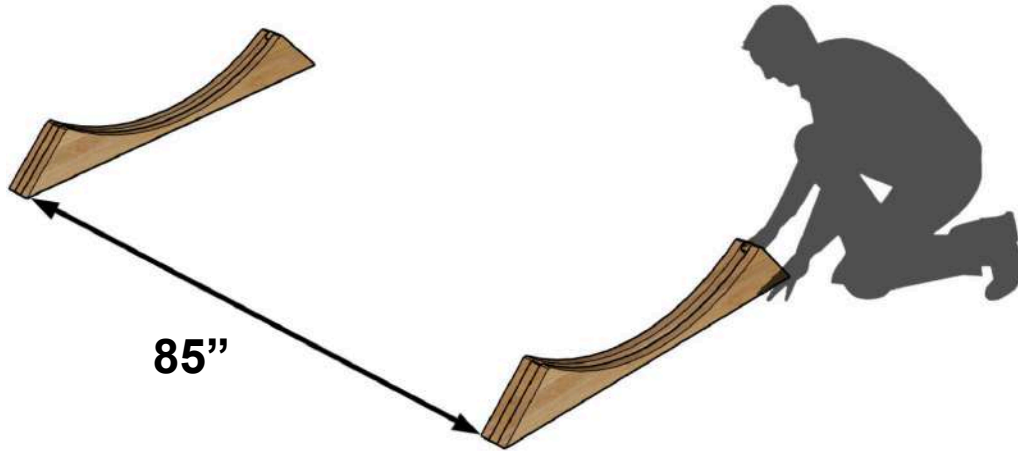

Place the barrel supports approximately **85" inches (2159 mm)** apart.

2



**Stave Profile**

Identify the bottom stave (shown in the image above) and center the stave on the cradle supports. The long part before the groove will face the front. Ensure the groove on the stave is facing upwards.

## BOTTOM FRAME assembly

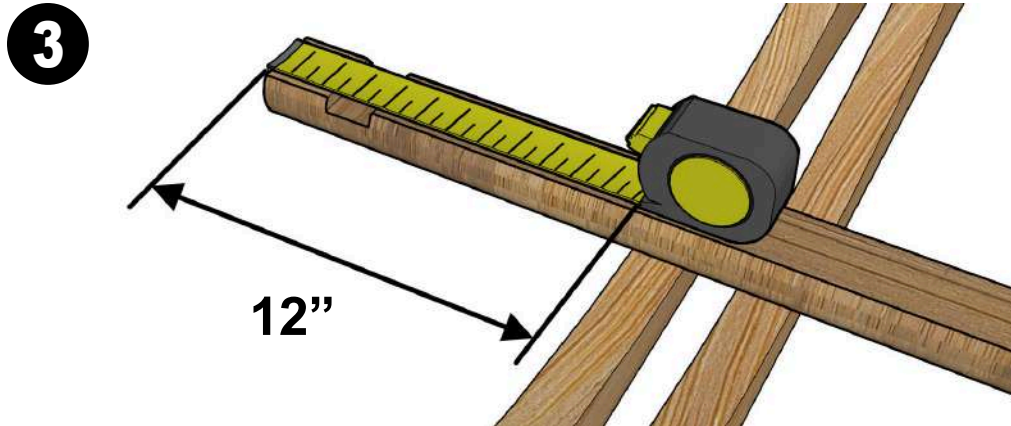

Measure **12 inches (305 mm)** from end of stave to the edge of the cradle support.

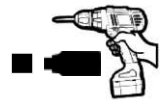
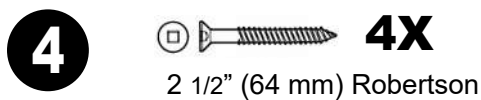

Secure the stave with a screw ensuring the stave is square. Add three more screws to each corner of the cradle support (See image above).

**PLEASE NOTE:** It is important to use the correct screw length. A screw too long could possibly go through the cradle support or a screw too short will not have enough thread to provide hold.

## BOTTOM FRAME assembly

5

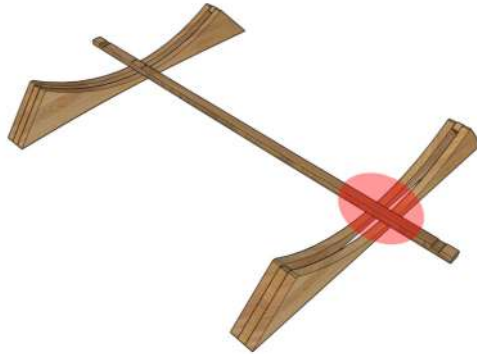

Repeat **Steps 3-4** for the opposite end of the bottom stave.

6



After securing both the front and back cradle support move a third cradle to the middle of the assembly.

7

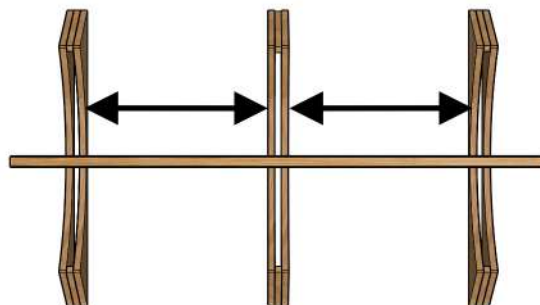

Center the middle cradle support between the front and back cradle support.

## BOTTOM FRAME assembly

8

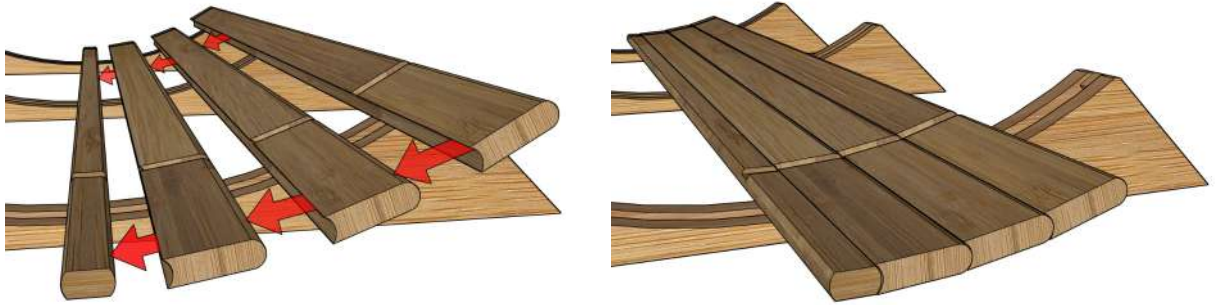

Place 3 staves against the bottom stave sliding each piece tightly against the next. Ensure that you align the grooves of each stave.

9

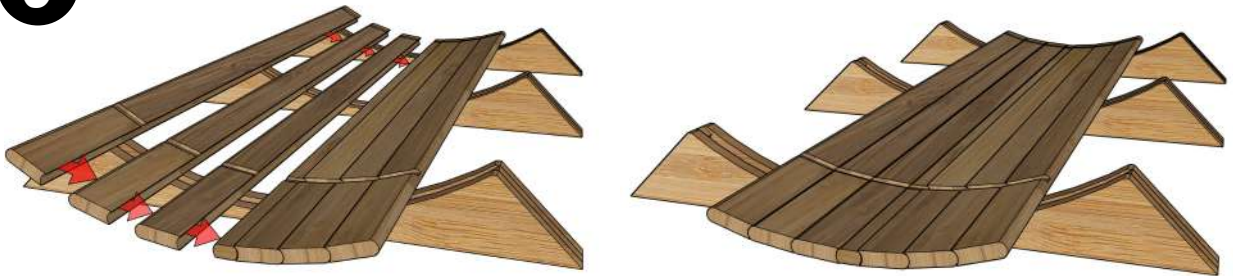

Place 3 additional staves on the opposite side of the bottom stave. Slide each piece tightly against the next. Ensure that you align the grooves of each stave.

## BOTTOM FRAME assembly

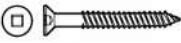
**10**  **4X**  
2 1/2" (64 mm) Robertson

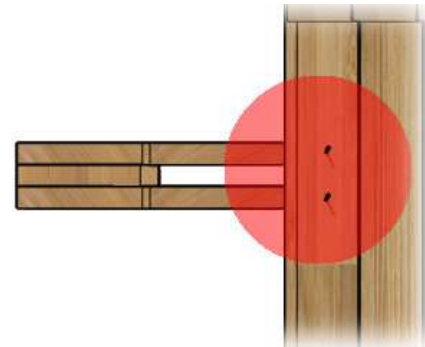
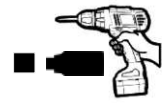
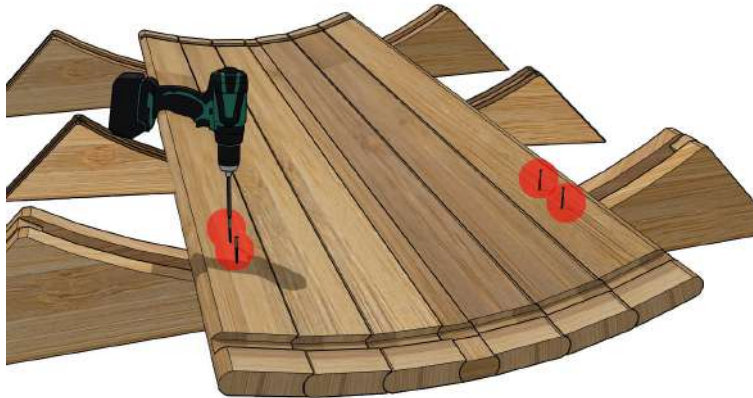

Ensure the screws line up with the cradle boards underneath.

Secure the staves by placing two screws on each of the end staves (see image above).

Do not put the screws through the bottom stave all the way. This will help align the cradle and leave the frame flexible for further adjustment.

**11**  **4X**  
2 1/2" (64 mm) Robertson

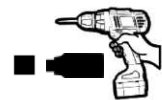
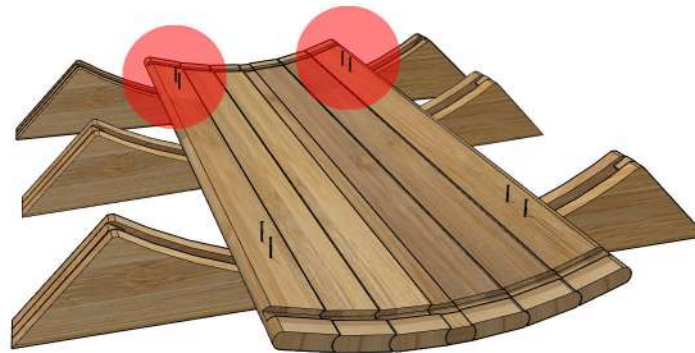

Continue securing screws on the opposite end of the board.

**PLEASE NOTE:** Do not put the screws through the bottom stave all the way. This will help align the cradle but leave the frame flexible for further adjustment.

## FRONT & REAR WALL assembly

12

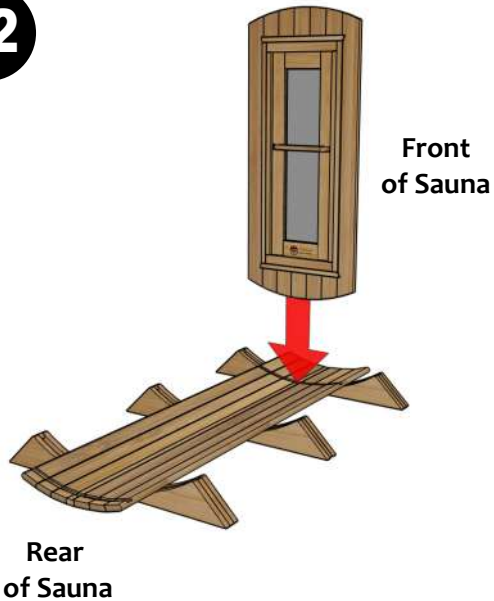

Place the door onto the grooves of the bottom frame. Ensure the door is placed to the front of the sauna. Ensure the logo etched on the door is to the bottom and facing inwards to the bottom frame (See image above).

13



Using a level and rubber mallet, tap the door until it is centered and level. (See image above).

## FRONT & REAR WALL assembly

14

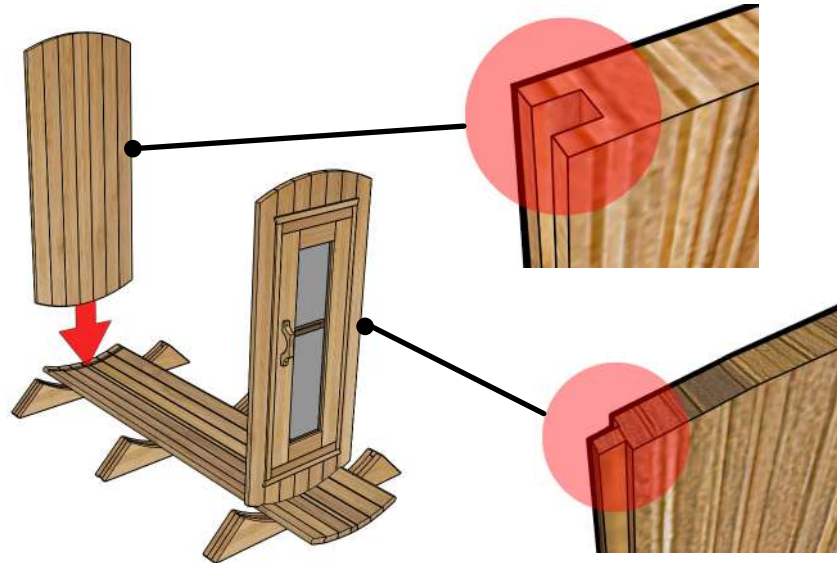

Install the back wall panel onto the grooves of the bottom frame.  
Ensure the tongue and grooves are opposite to each other from the front and back panels.

15



Use a level and mallet to center and level the wall section.

## FRONT & REAR WALL assembly

16

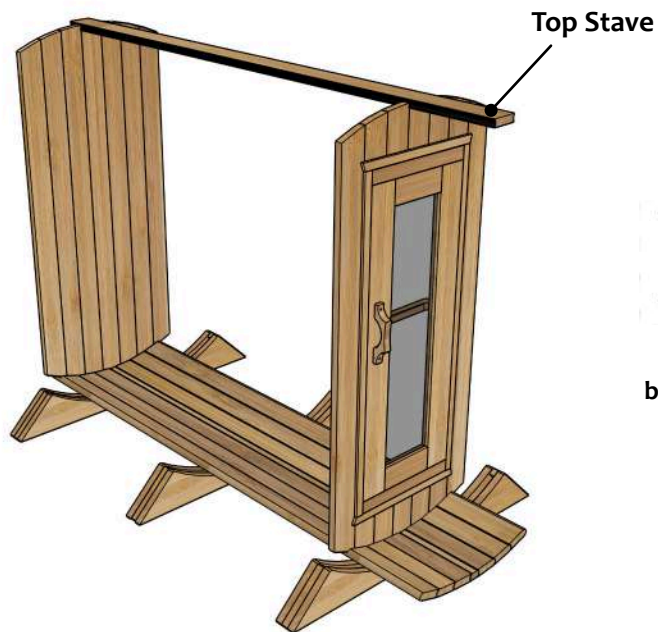

Identify the top stave by looking at the front profile

Connect the top stave between the front and back panel to help stabilize the sauna. Ensure the groove in the top stave is facing downwards and connects with the wall panels.

17

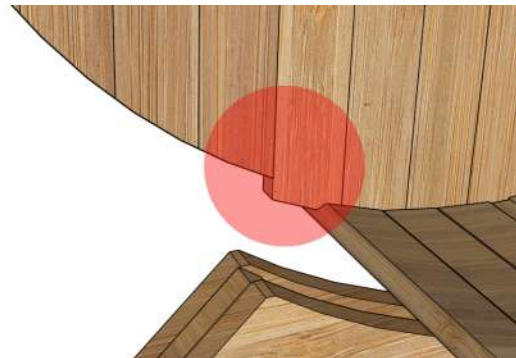
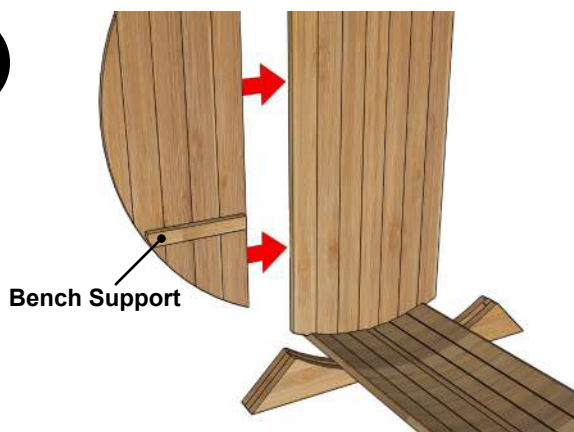

Panels may not be exact size to middle wall.

Secure the rear wall half-moon panels. Ensure the bench support is facing inwards to the sauna frame.

**Please Note:** Panels may not be exact size to middle wall. Use the pencil marks on the panel as a guide to center the panel.

## FRONT & REAR WALL assembly

18

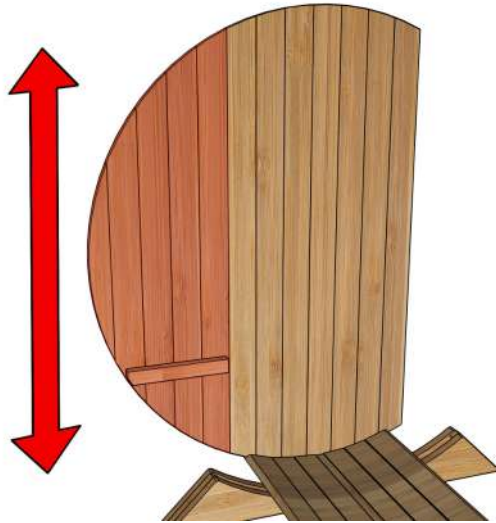

Center the half-moon panels vertically on the middle wall and secure in place.

19

 **2X**  
2 1/2" (64 mm) Robertson

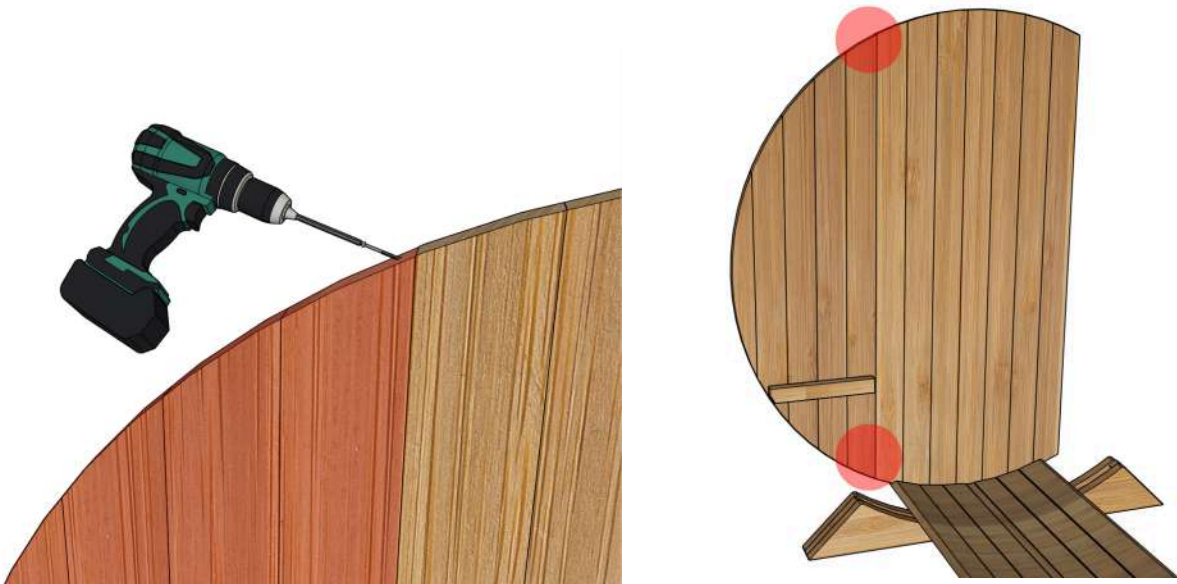
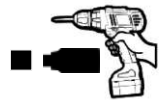

Fasten the connection between the side panel and the middle panel in the predrilled holes located at the top and bottom of the panel.

## FRONT & REAR WALL assembly

20

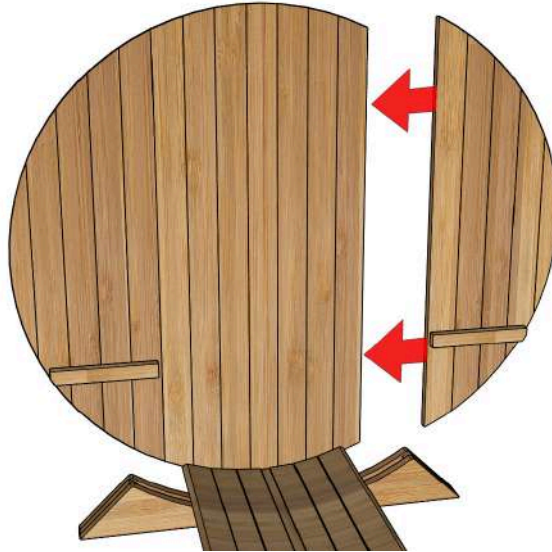

Repeat and follow **Steps 17-19** to install the second half-moon panel.

21

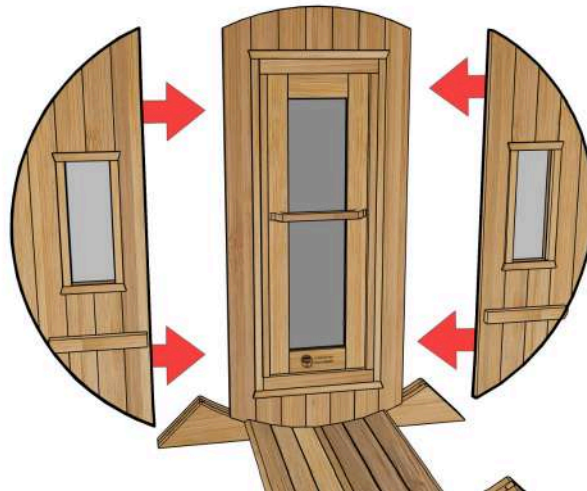

Follow **Steps 17-19** as a guide to secure the front wall half-moon panels to the front panel.

## CURVED WALL assembly

22



Continue adding staves on either side of the sauna a few at a time, alternating sides. Use the rubber mallet to finesse the staves into place.

23



**2X EVERY SECOND STAVE**

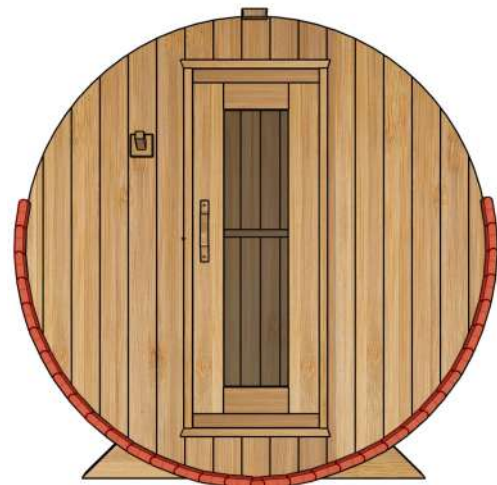
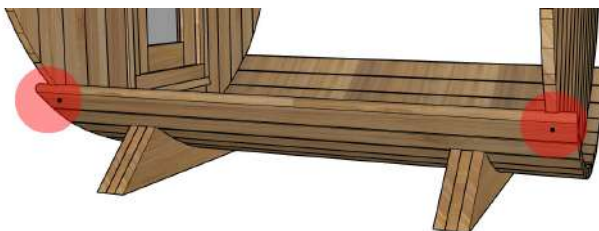
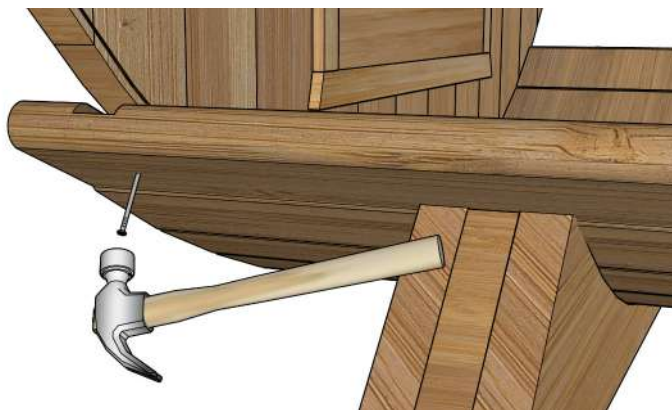

**PLEASE NOTE:** Once past the middle point of the sauna, nails should no longer be needed.

Secure every second stave on the bottom of the sauna with the provided nails to hold staves in place. Add a nail to both ends of the stave.

## CURVED WALL assembly

24

Pencil Line

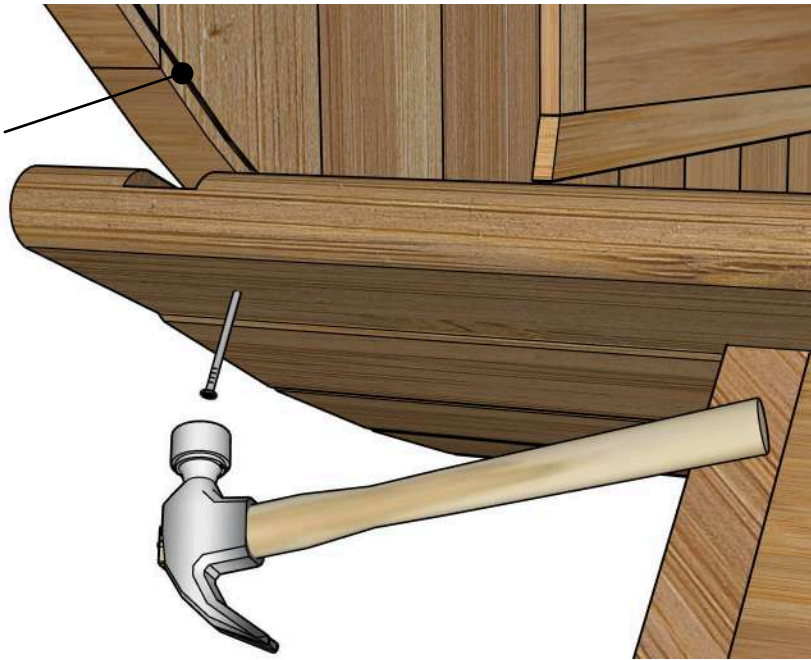

When installing the staves, tap tightly together while leaving as much of a gap as possible between stave and wall using the pencil line as a guide as in picture. **This will make the tightening of the bands easier**

25

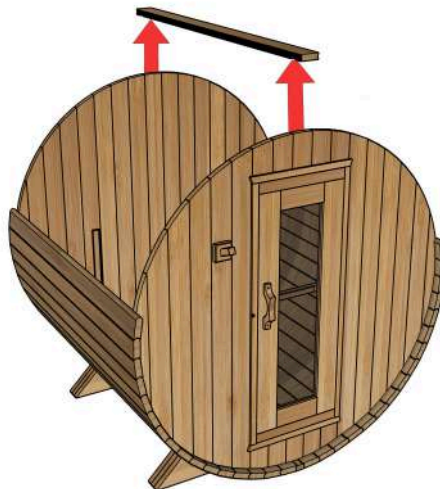

Remove the top stave and put it aside while continuing to add staves on both sides until you reach the top of the sauna.

## CURVED WALL assembly

26



Top Stave Shape

Use the top stave to wedge with the last stave to create a “V” shape.

- If you experienced no problems with fitting the staves snugly to create a “V” shape then continue to **Step 27**.
- If the staves cannot be loose to create a “V” shape or there is a gap between the staves, you may need to add one of the spacer boards to the top stave. Continue to **Step 26 A**.
- If your sauna staves are too tight to allow the staves to settle into a “V” shape you may need to make the top stave narrower. Continue to **Step 26 B**.

26A

If the staves are too loose to create a “V” shape or there is a gap between the staves, you may need to add one of the spacer boards to the top stave.

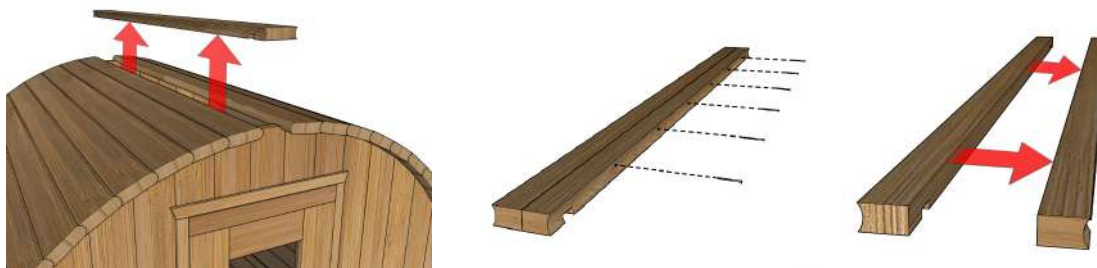

Begin by removing the top stave from the top of the sauna. The top stave is actually two pieces held together by screws. Begin by removing the screws holding the top stave together. Separate the stave into two pieces.

## STAVES TOO LOOSE

26A



In your sauna package there is a square spacer the same length as the top spacer. Take this stave and position it between the two top stave pieces. Refasten all three pieces with the screws that held the top stave together. See image above for details.



Reattach the new top stave to the same position on the roof line. Continue with **STEP 27**.

26B

In rare instances, your sauna staves might be too tight to allow the staves to settle into the correct position and be aligned with one another. This doesn't happen often, and the sauna staves and bands are always better being as tight as possible.

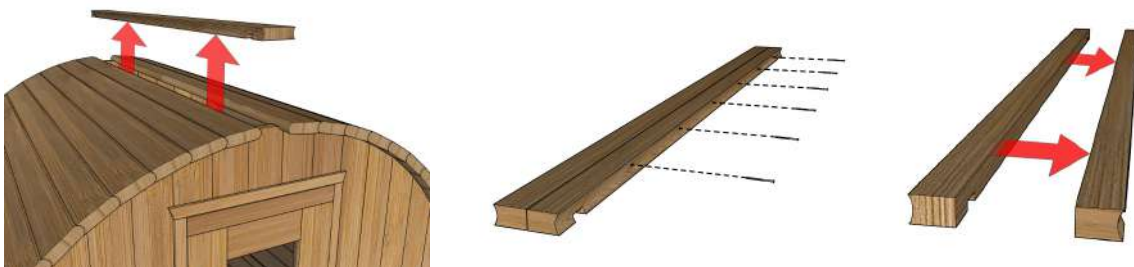

Begin by removing the top stave from the top of the sauna. The top stave is actually two pieces held together by screws. Remove the screws holding the top stave together and separate the stave into two pieces.

# STAVES TOO TIGHT

26B

Continued from last page

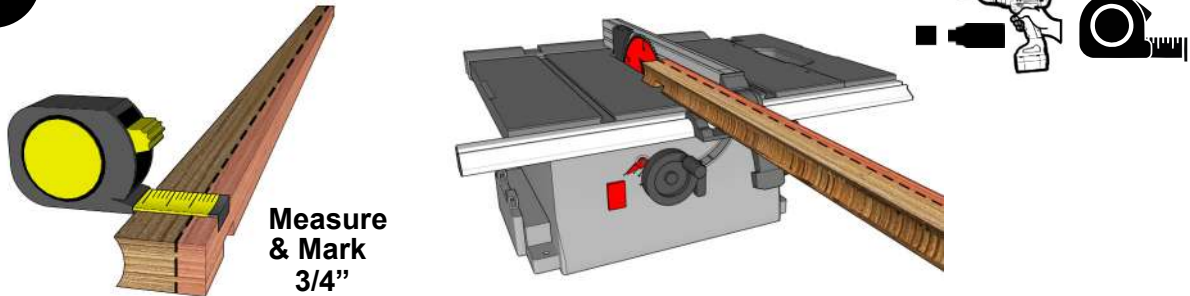

Measure and mark **3/4 inches (19 mm)** on both stave pieces from the flat side of the stave. Using a circular or table saw safely cut off 3/4 inches off each stave piece to make them thinner. Discard the wood cut off and reassemble both pieces (see image below) with the cut edge of each piece facing the other.

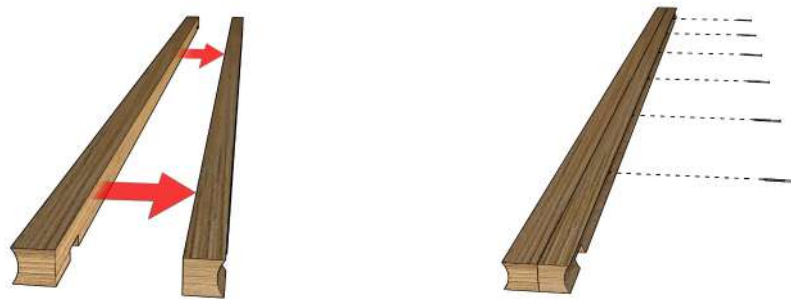

Refasten both stave pieces with the screws that held the top stave together. See image above for details.

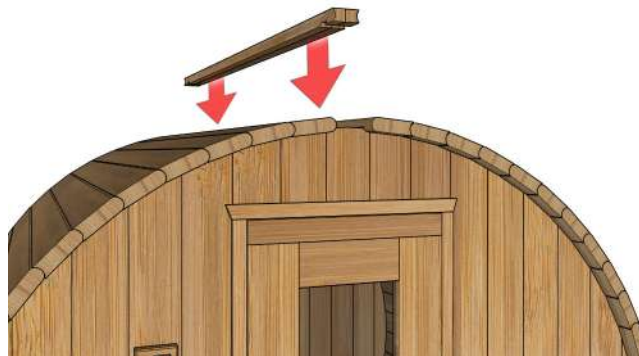

Reattach the new top stave to the same position on the roof line. Continue to **STEP 27**.

# STEEL BAND assembly

27

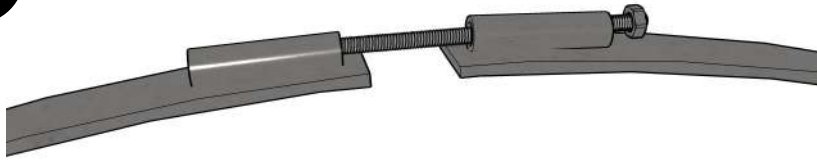

3/4" (19 mm)

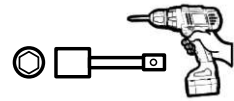

Pre-assemble two bands and thread the nut on just enough to secure the band. Leave the two remaining bands unassembled.

28

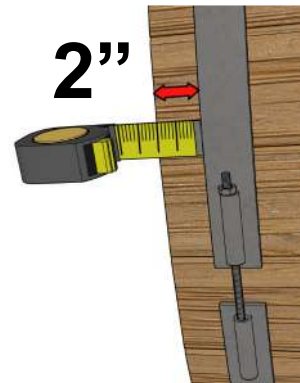

Place one band over each end of the sauna. Ensure each end is placed evenly 2" (51 mm) from the ends of the sauna.

29

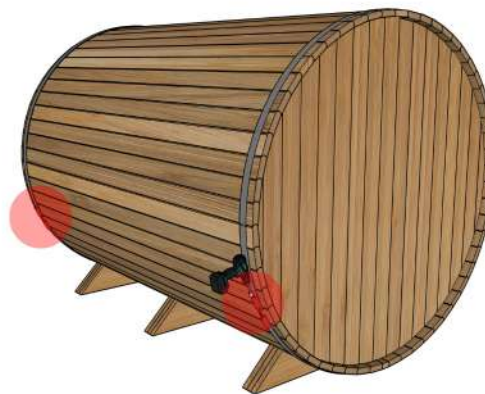

3/4" (19 mm)

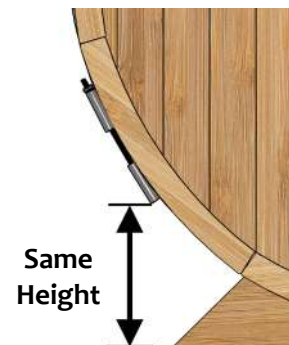
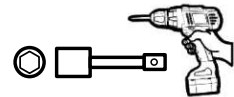

Ensure all steel bands on the sauna are set to the same height. Lightly snug up the front and rear steel bands.

## STEEL BAND assembly

30

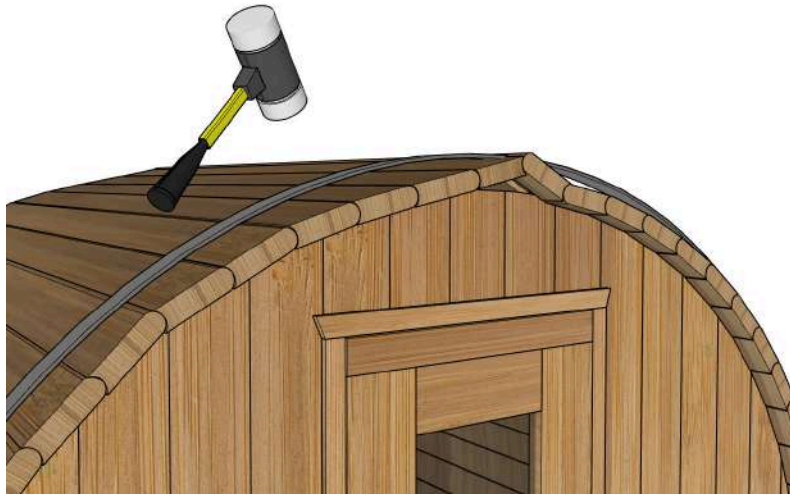

Tap out all the staves to even them out.

31

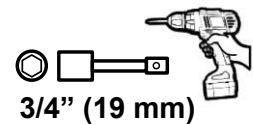
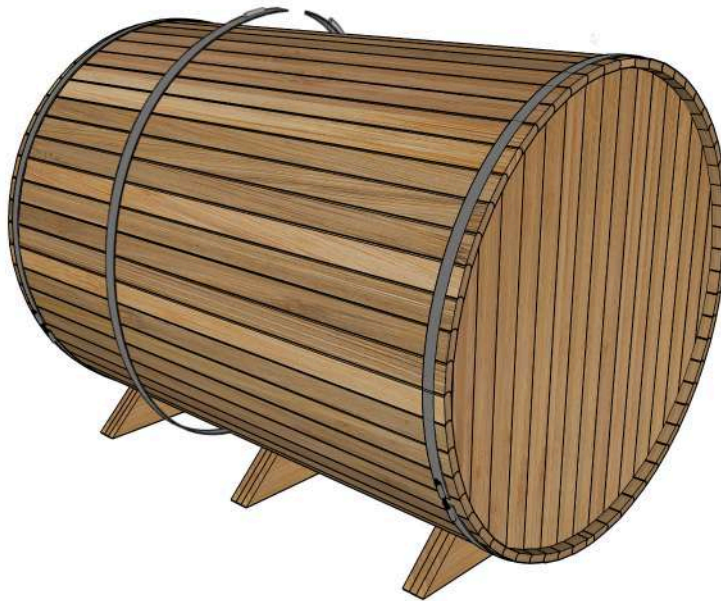

Position a third band over and under the sauna and secure it with a rod and nut.  
Position it near the front steel band.

## STEEL BAND assembly

32

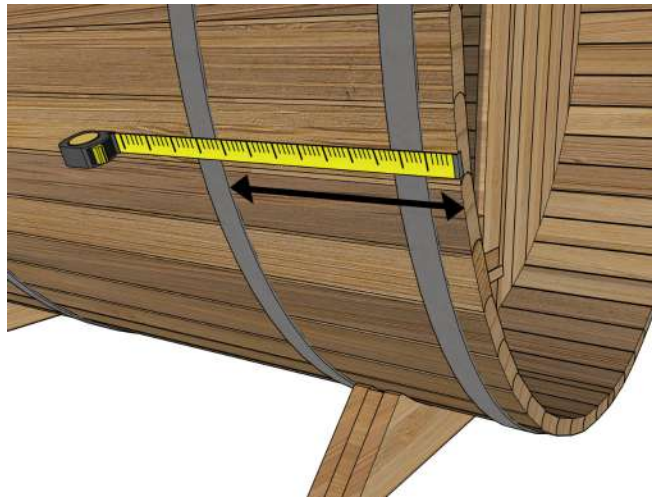

Ensure the third band is positioned **17" (432 mm)** from the front of the sauna.  
Check that the band is **17"** distance all the way around the sauna.

33

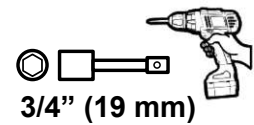
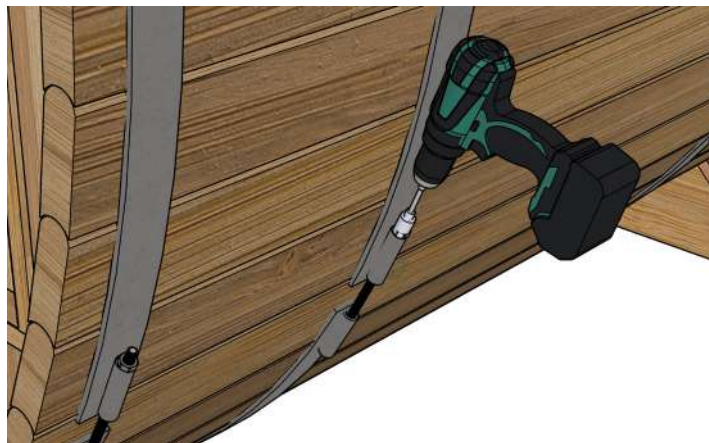

Snug the middle band.

## STEEL BAND assembly

34

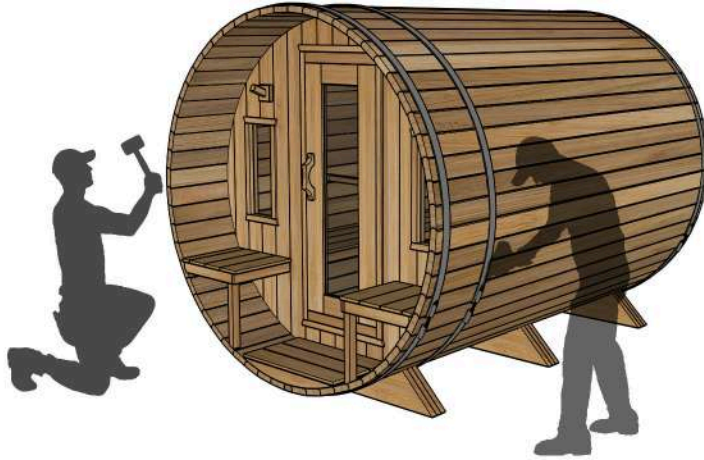

Tighten fasteners on the middle band while a helper continues to tap on the staves.  
Repeat this process for the rear band.

35

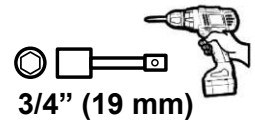

Give the middle band a final tightening.  
**PLEASE NOTE:** Don't worry about making the bands too tight as they cannot be overtightened.

## STEEL BAND assembly

36

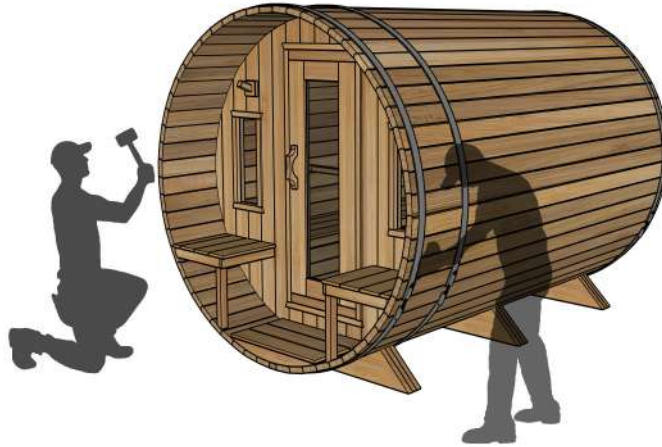
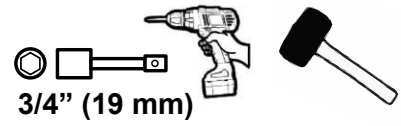

Tighten fasteners on the front band while a helper continues to tap on the staves.

37

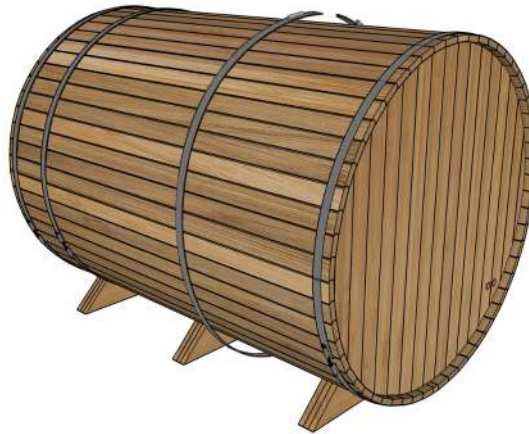
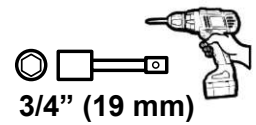

Now feed the fourth band around the sauna and secure it with a rod and nut. Position it near the rear of the sauna.

## STEEL BAND assembly

38

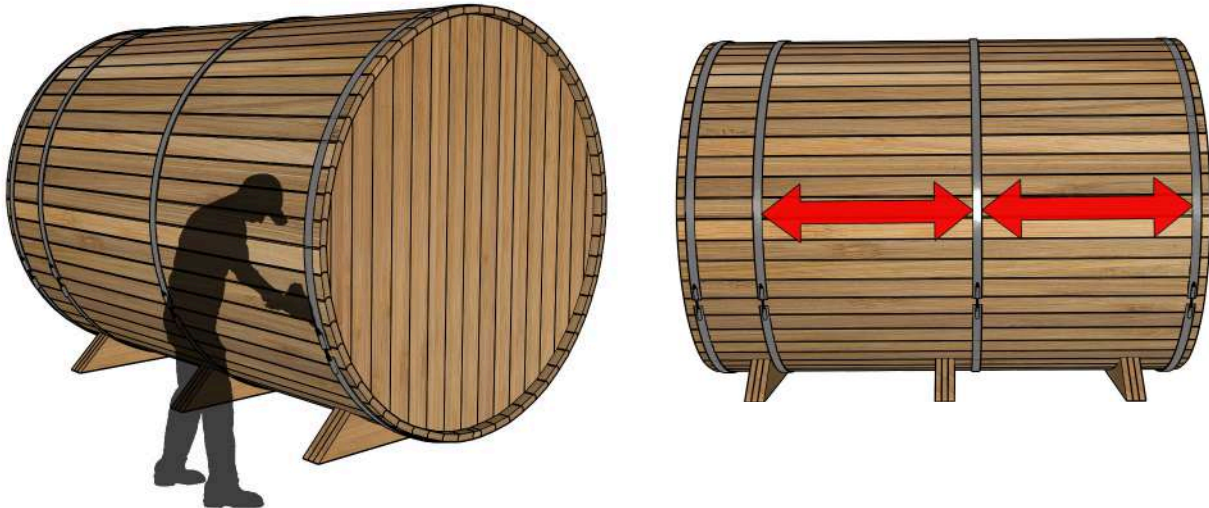
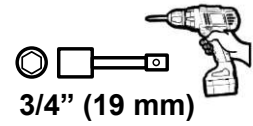

Ensure the fourth band is centered between the rear and middle bands.  
Ensure all fasteners have a final tightening.

**PLEASE NOTE:** Don't worry about making the bands too tight as they cannot be overtightened.

39

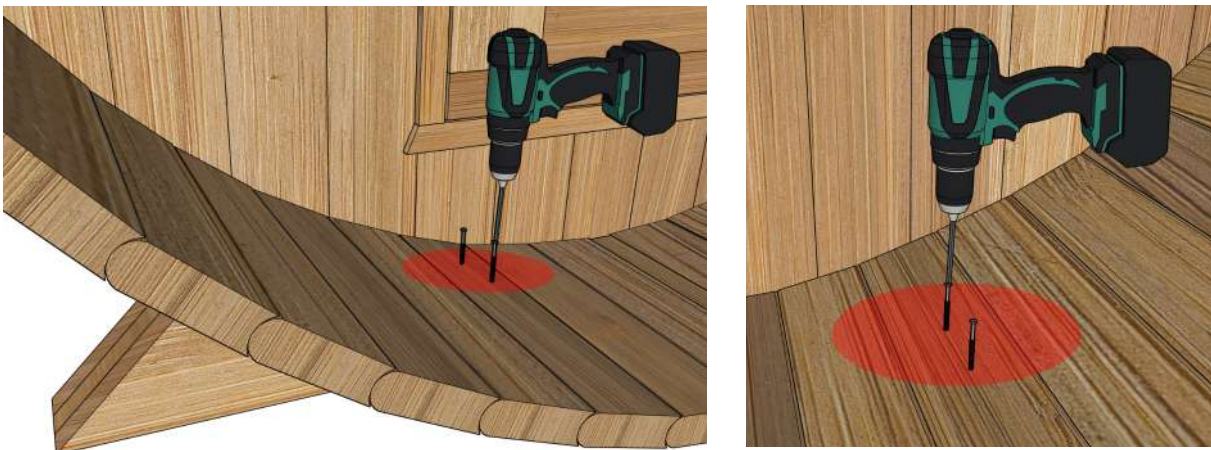
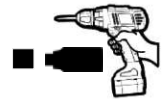

Tighten the screws from **STEPS 10** located on the outside of the sauna and **STEPS 11** located on the inside of the sauna.

## FLOOR assembly & installation

40

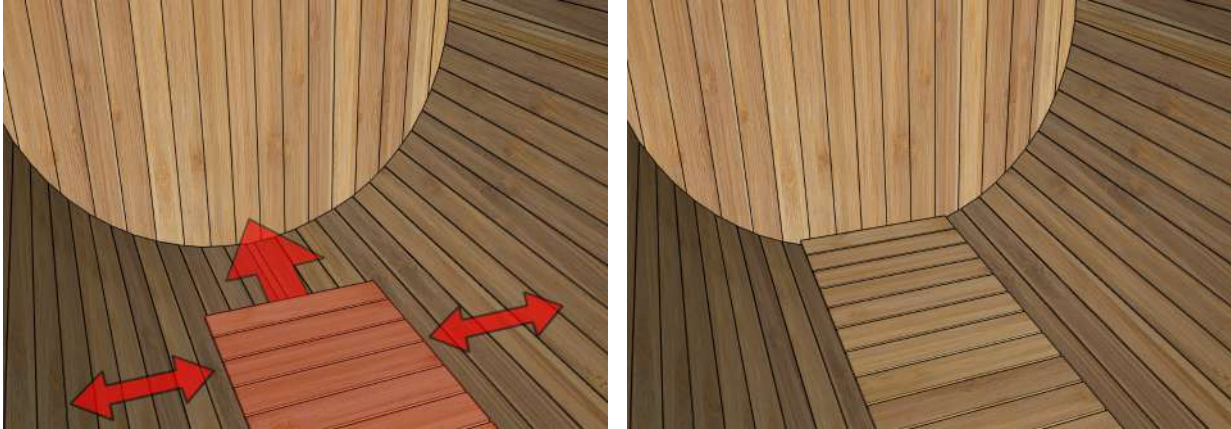

Place the flat floor piece inside the sauna towards the back wall.  
Center the floor in the middle of the sauna.

41



Ensure the floor is level.

## FLOOR assembly & installation

42

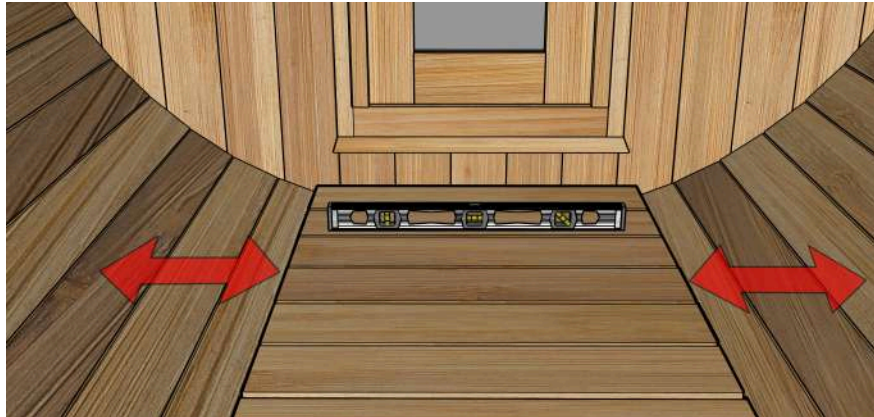

Ensure the floor is snug against the front wall and centered in the middle of the sauna.

43



**6X**

1 1/2" (38 mm) Robertson

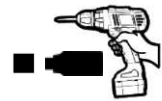

Once level, secure the floor with screws in the 4 corners and 2 in the middle of the flat floor. Screw between the floorboards so the screws are not as visible.

## FLOOR assembly & installation

44

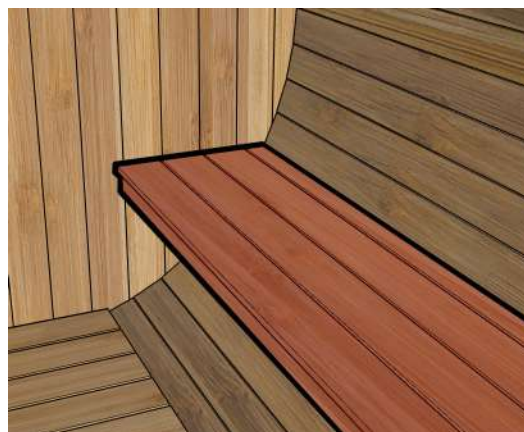
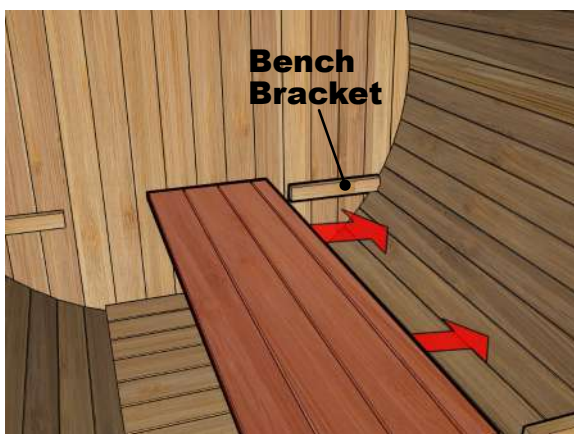
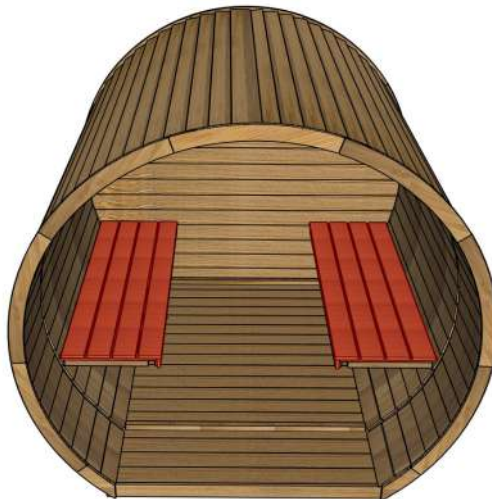

Bring a bench top inside the sauna. Place the bench top on the bench brackets and slide the bench top until it is tight against the wall. Ensure that the bench top is against the wall on both ends of the bench top.

# BENCH assembly & installation

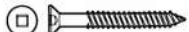
**45**  **4X**  
1 1/2" (38 mm) Robertson

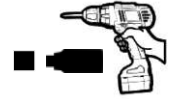

Secure the benches to the bench brackets with screws in each of the corners of the bench. Position the screws between the bench slats so they are not as visible.

**46**  **8X**  
1 1/2" (38 mm) Robertson

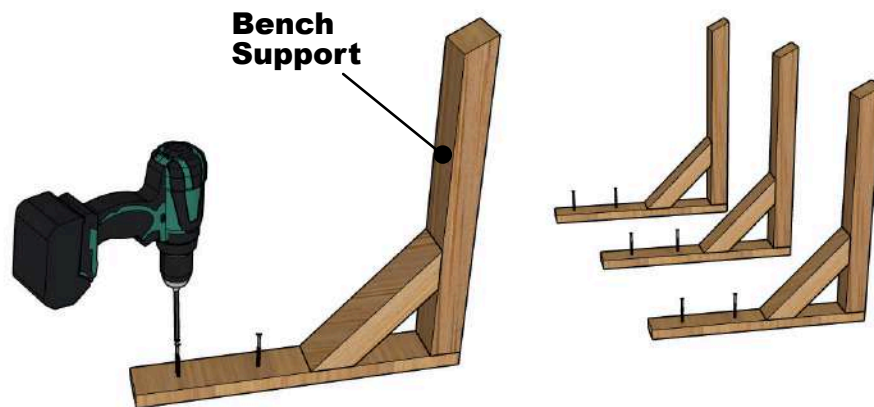
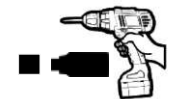

Prepare the bench supports by placing two screws into the pre-drilled holes for each support.

## BENCH assembly & installation

47

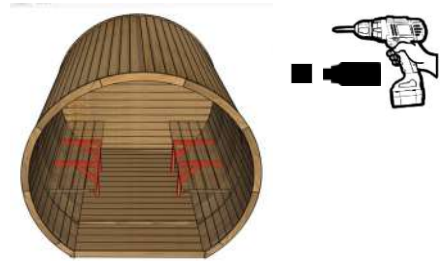

Line the bracket up with the support on the bottom of the bench and secure it with the pre-placed screws.

48

 **4X**  
1 1/2" (38 mm) Robertson

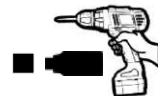

Square up the bench support and use a screw in the pre-drilled hole to secure it to the sauna floor. Follow this process for the remaining bench supports. Repeat **STEPS 44-48** for the second bench.

## DOOR HANDLE installation

49



50



Place the outer door handle at desired height.

Ensure it is centred and secure with screws.

51

 **2X**  
2 1/2" (64 mm) Robertson

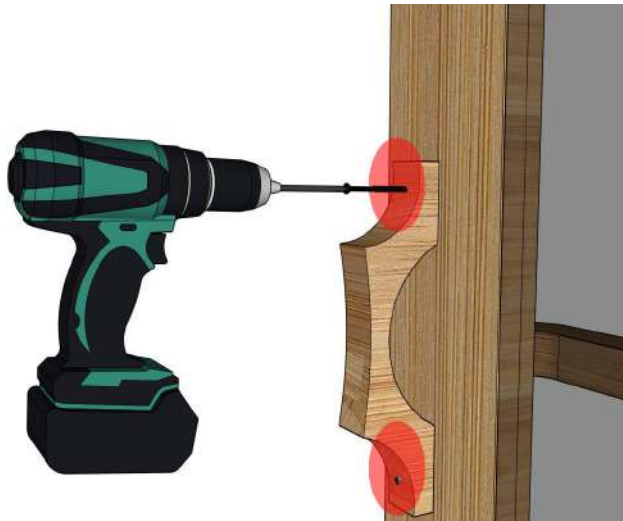

Fasten with 2 screws in the pre-drilled holes .

## DOOR HANDLE installation

52



Place the inner door handle at desired height.

53

 **2X**  
2 1/2" (64 mm) Robertson

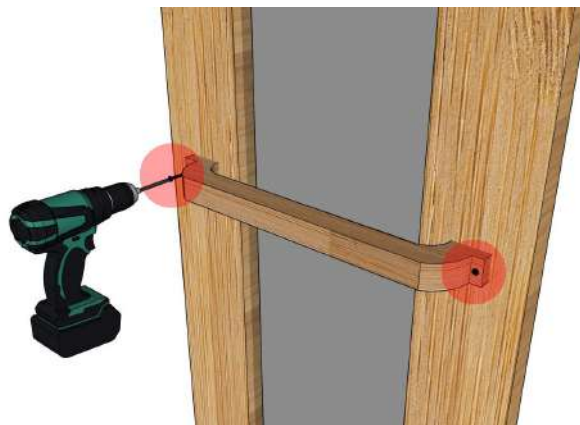

Fasten with 2 screws. Ensure handle is installed level and secure.

## OUTSIDE BENCH installation

54



Position and center the porch floor. Ensure it is level.

55

 **4X**  
1 1/2" (38 mm) Robertson

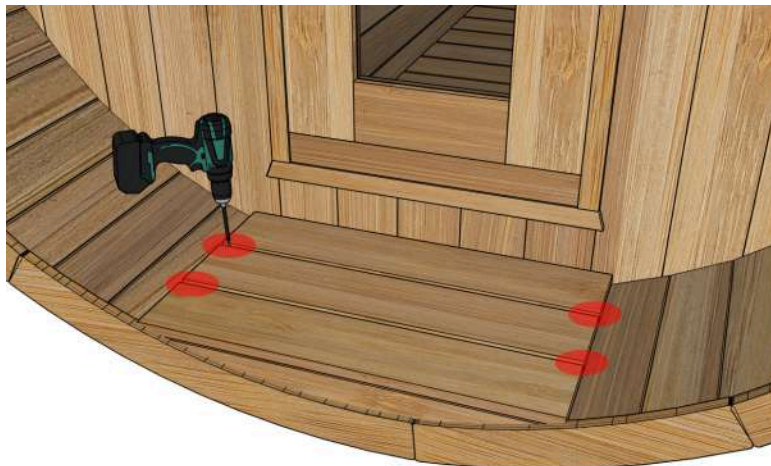
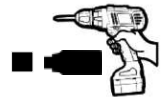

Once level secure the porch floor to the bottom of the sauna with a screw in each corner.

# OUTSIDE BENCH installation

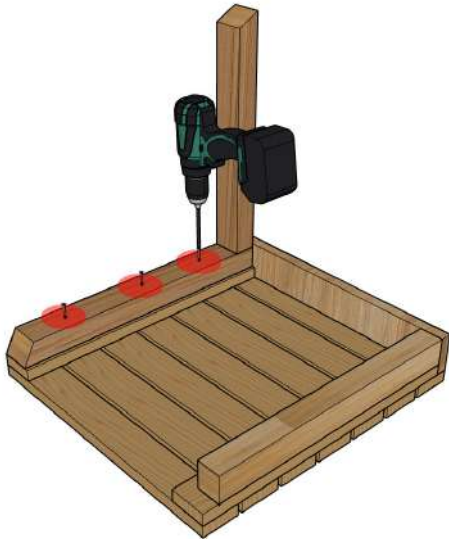

Screw the porch bench bracket to the porch seat with screws. Ensure the bracket is installed with the pre-drilled hole at the bottom of the bracket.

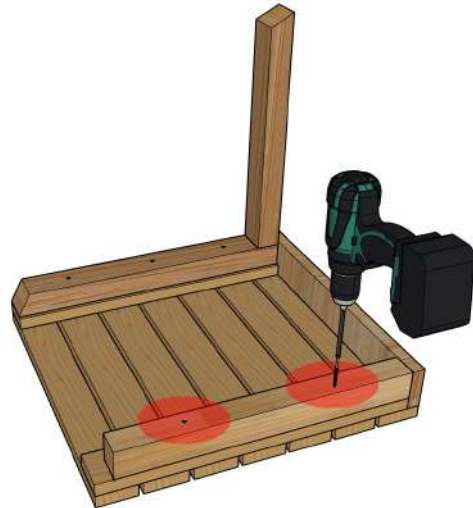

Screw the porch bench bracket to the porch seat with screws. Ensure the bracket is installed with the pre-drilled hole at the bottom of the bracket.

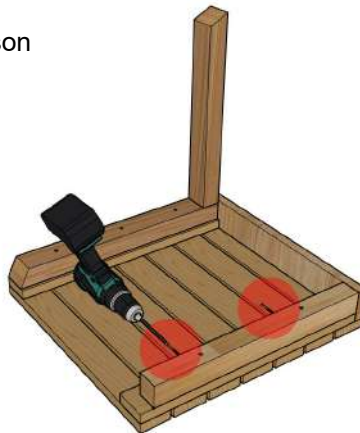
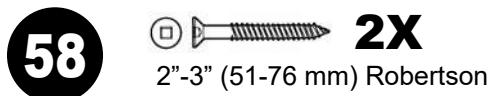

Add two screws to the inside of the wall support to make mounting easier. Connect the screws to the wood but do not tighten all the way.

## OUTSIDE BENCH installation

59

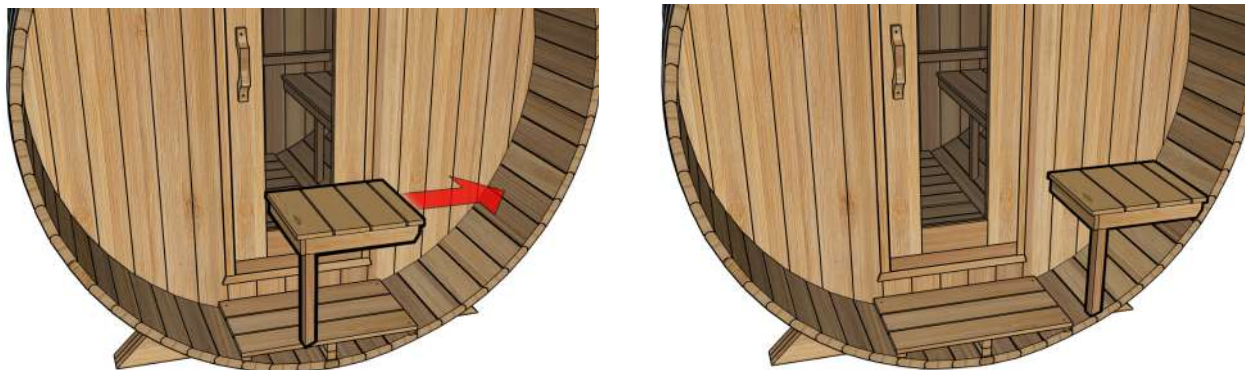

Position the first bench against the side wall.

60

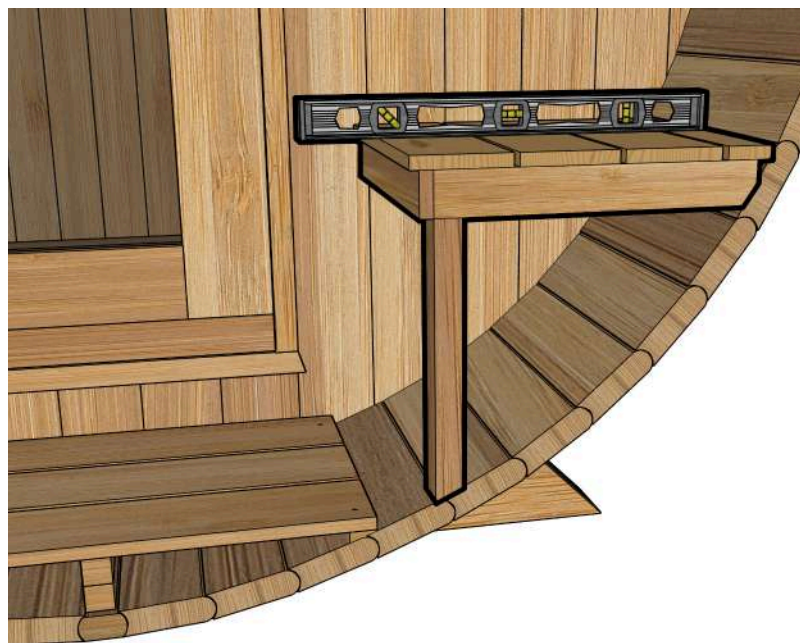

Ensure the bench is level.

## OUTSIDE BENCH installation

61

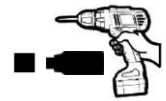

Secure the bench with the screws that were added in **STEP 58**.

62



1X

1 1/2" (38 mm) Robertson

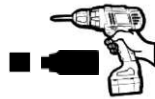

63

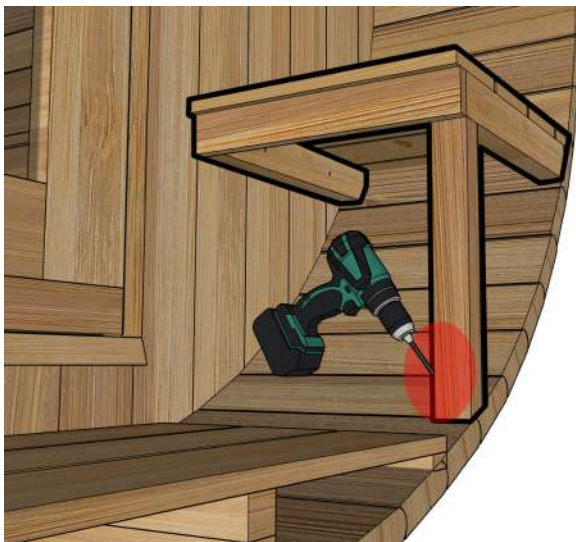

Ensure the bench support is flush with the edge of the sauna. Use a screw in the pre-drilled hole to secure it to the sauna floor.



Repeat **STEPS 56-62** to assemble and install the second outside bench.

# SHINGLE installation

If you are installing the optional asphalt roof to your sauna follow **STEPS 64-81**.  
If you are **not** installing the optional asphalt roof please skip to **STEP 82**.

**64**

 **12X**  
2" (51 mm) Robertson

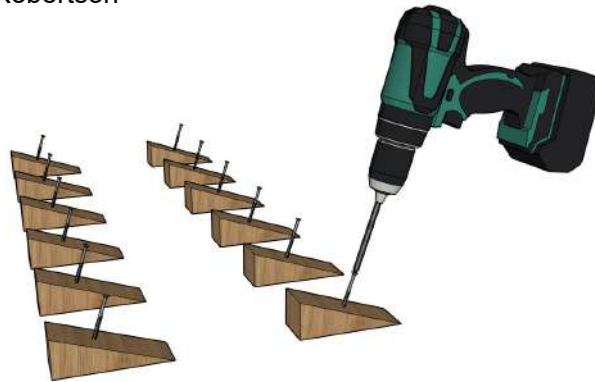
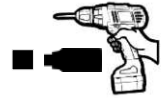

Preplace **2" (51mm)** screws into the middle of each triangle support piece.

**65**

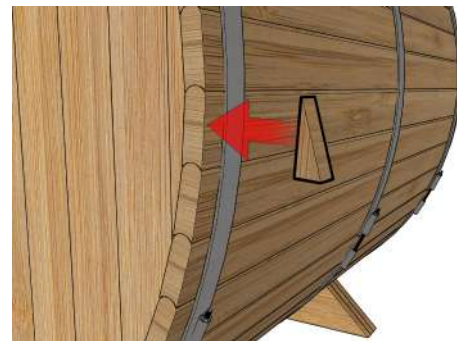
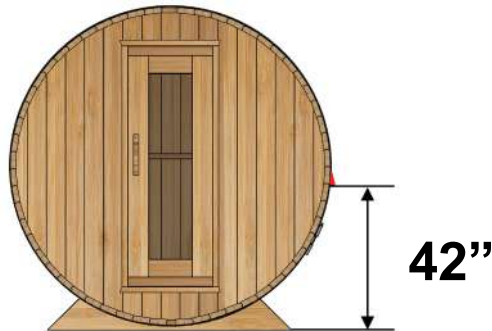

Install the first triangle support piece **42" (1067mm)** from the base of the sauna.

## SHINGLE installation

66

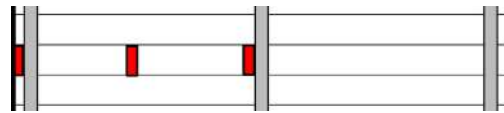
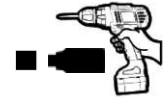

Install the next triangle support in the middle of the sauna. Add a third triangle support centered between these two supports (See image above for spacing).

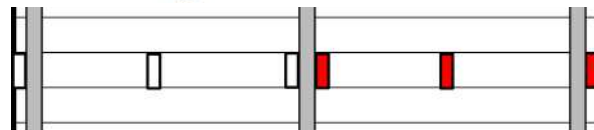
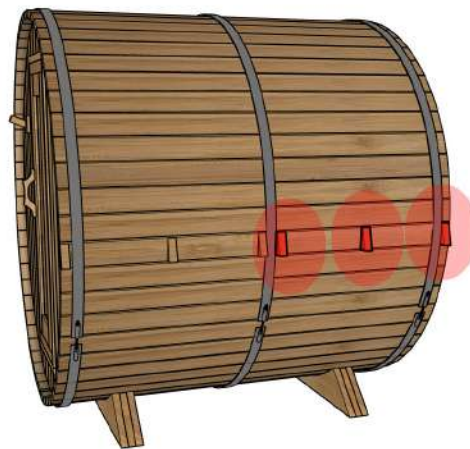

Install another triangle at the opposite end of the sauna. Install the next triangle support in the middle of the sauna and add a third centered between these two supports. There should be 6 triangle supports installed to this side of the sauna.

## SHINGLE installation

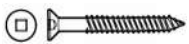
**67**  **6X**  
2" (51 mm) Robertson

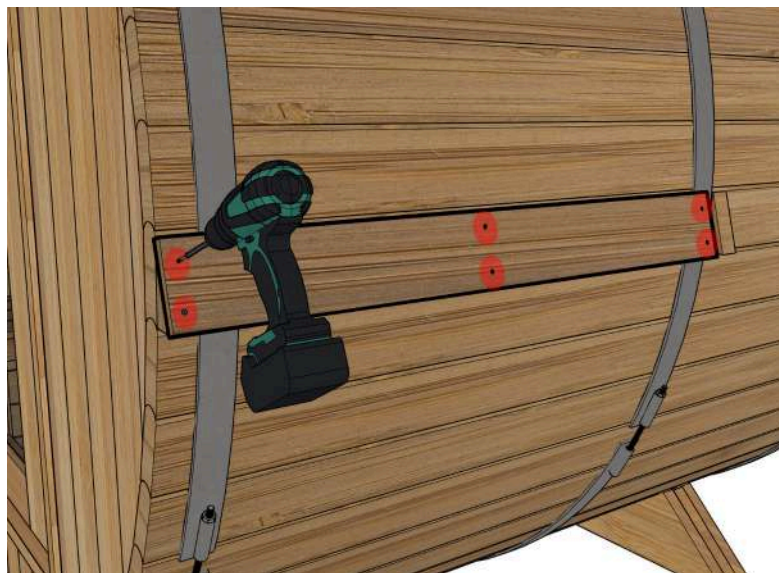
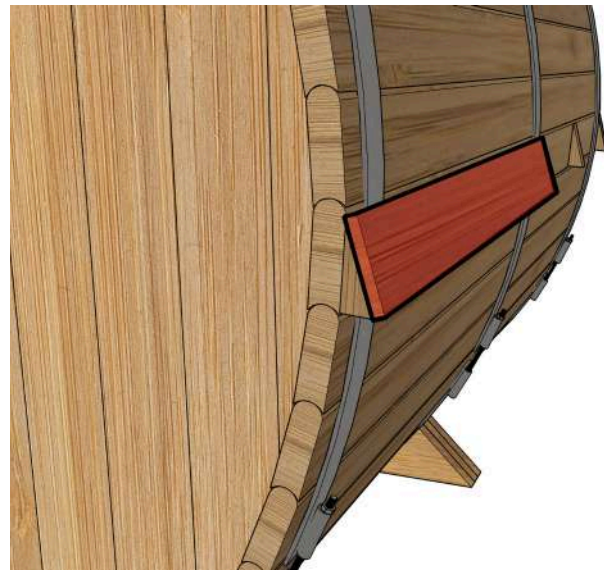
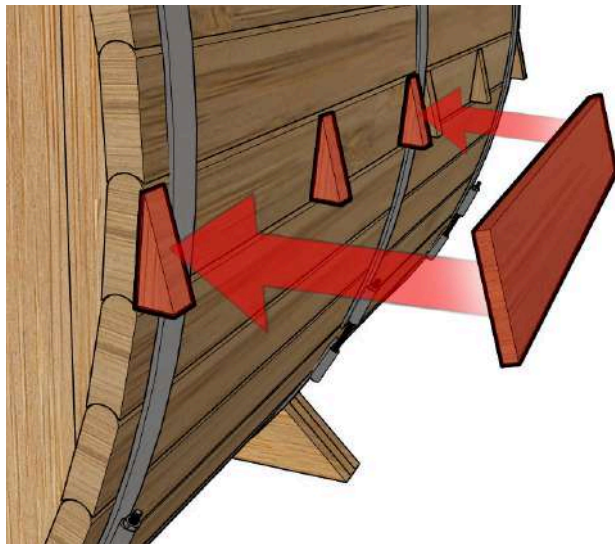
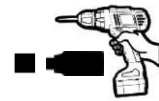

Place the ice and water support boards flush to the bottom of the triangle supports and secure with screws in each of the triangle supports.

## SHINGLE installation

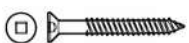
**68**  **6X**  
2" (51 mm) Robertson

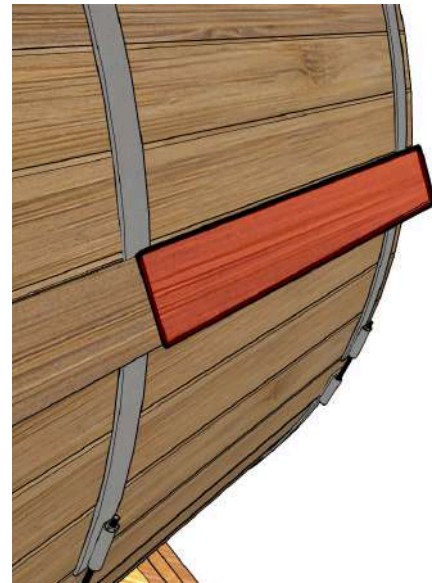
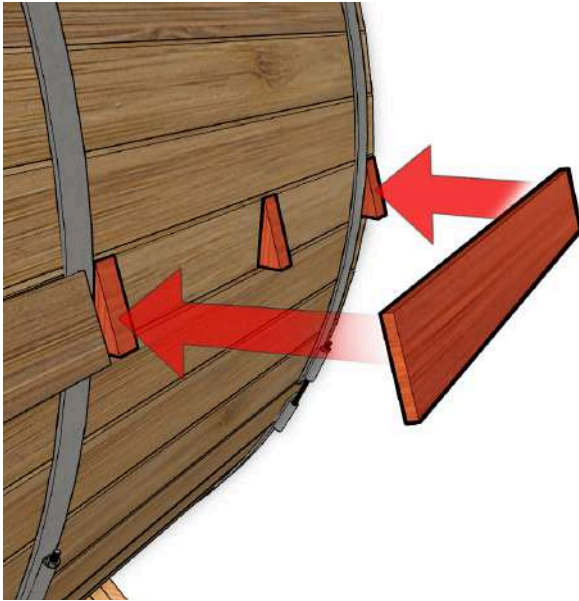
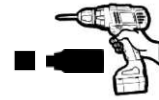

Place the ice and water support boards flush to the bottom of the triangle supports and secure with screws in each of the triangle supports.

## SHINGLE installation

**69**

Repeat **STEPS 65-68** to add ice and water support boards for the opposite side of the sauna.

**70**

 1 1/4"  
Staples



Peel the film off of the sheet of ice and water shield. Make sure the shield is aligned with the bottom the supports boards. Secure the shield with staples along the ends to hold in place.



**PLEASE NOTE:** The glossy strip of the ice and water shield should be placed on the top.

**71**

Repeat **STEP 70** for the ice and water shield opposite side of the sauna.

**72**

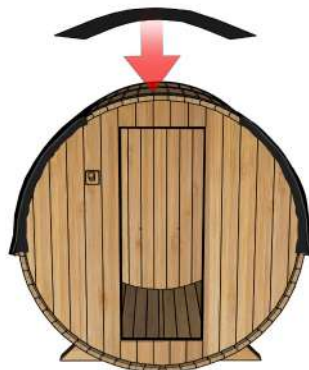

Continue with the next strip of ice and water shield for the top of the sauna. Ensure to overlap the top with the smooth portion of the previous strip on either side.

## SHINGLE installation

**73**  1 1/4"  
Staples

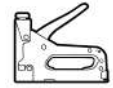

Fold the ends of the ice and water sheeting over and staple the ends of the side wall board to the sheeting. Do this for both the front and back of the sauna.

**74**



Using a utility knife cut the excess sheeting off both the front and back of the sauna frame.

## SHINGLE installation

**75**

 **3X**  
1 1/2" (38 mm) Robertson

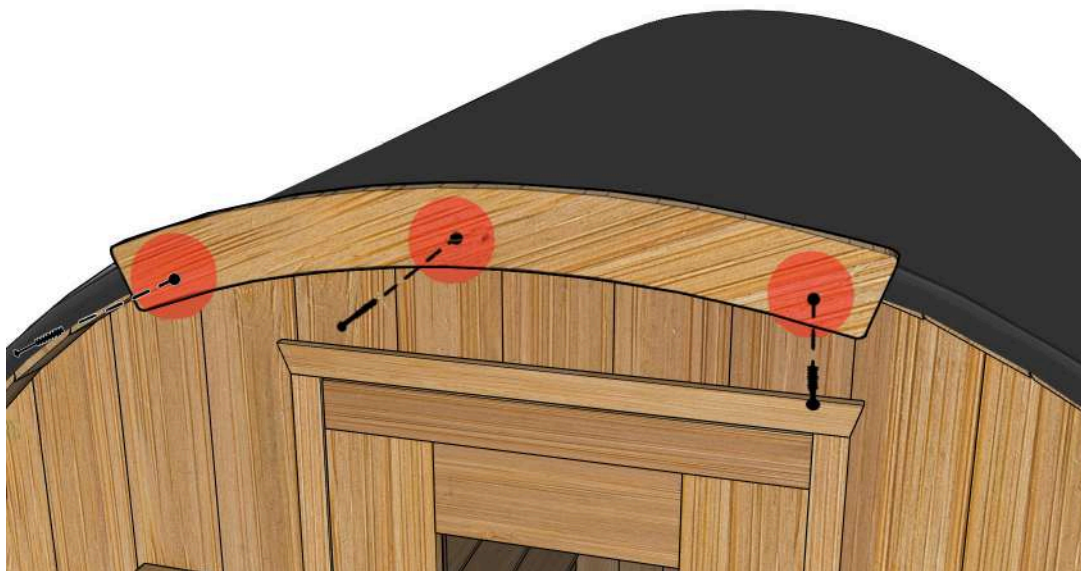
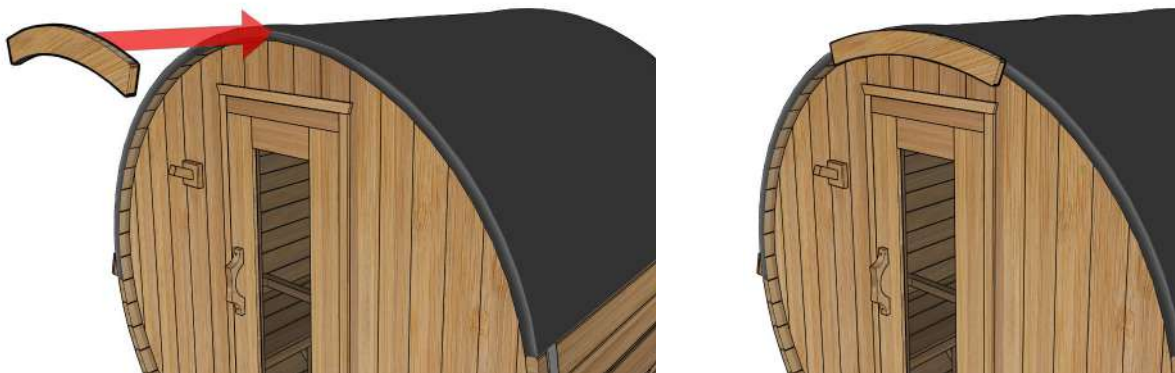
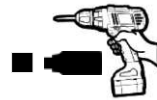

Position the first piece of trim to the front of the sauna frame. Fasten with three screws.

## SHINGLE installation

76

 **3X per piece**  
1 1/2" (38 mm) Robertson

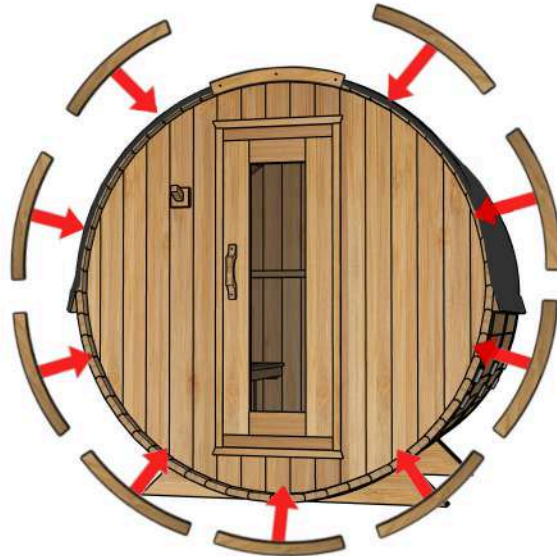
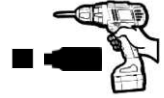

Continue working around the rim of the sauna adding more trim pieces on each side working your way to the bottom. Add 3 screws to secure each trim piece. The trim for the back of the sauna will be added later.

**PLEASE NOTE:** The last trim piece installed may need to be cut if the fit is too tight.

77

Roofing Nails

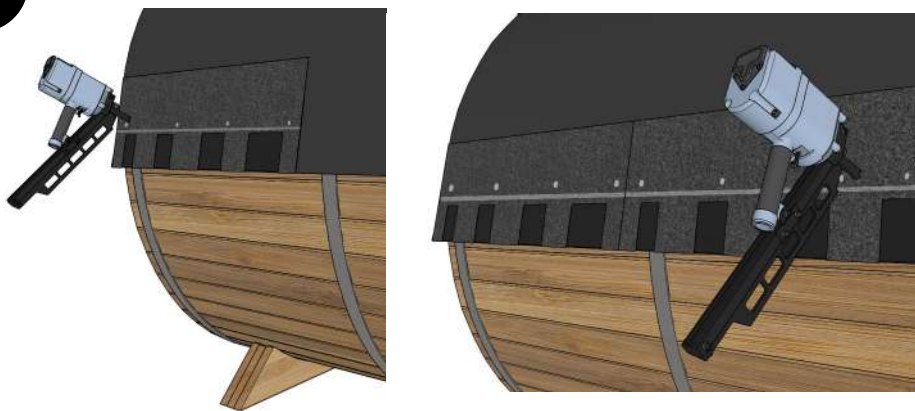

Begin placing shingles along the edge of the sheathing on the roof. Continue adding shingles along this row to the back of the sauna.

## SHINGLE installation

78

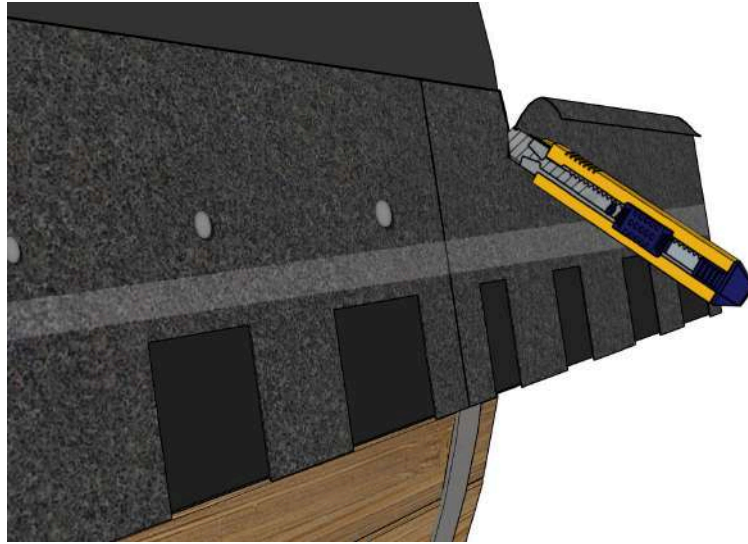

When you get to the back of the sauna, cut off the excess shingle to use for the next row.

79



Roofing Nails

Continue adding rows overlapping the previous row of shingles. Ensure you check the details on the shingle package for more information. Once you get to the center near the top of the sauna, start the process on the other side of the sauna working your way up to the top again.

## SHINGLE installation

80

Roofing Nails



When you get to the last row on this side, secure the top row with roofing nails in the top and middle of the shingle.

81

Follow **STEPS 75-76** for the wooden trim to be added on the back rim of the sauna.

## VENT installation

82



Position the vent cover on the upper front wall on the inside of the sauna.



The vent can also be positioned vertically depending on your preference.

83

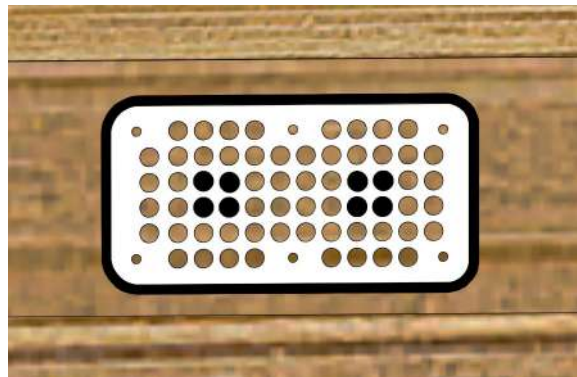
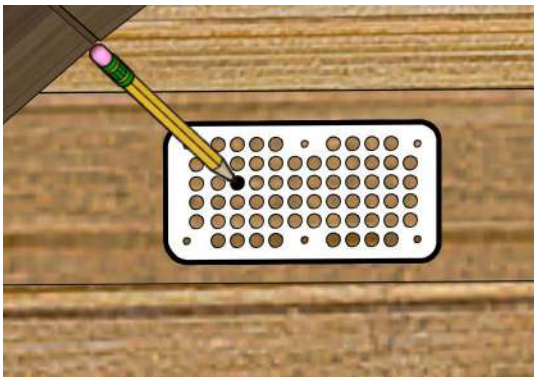

Using the vent cover as a template mark the dots as shown with a pencil.

## VENT installation

84

2" (51 mm) Holesaw Recommended  
1 1/2" (38 mm) Minimum

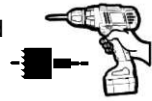

Remove the vent cover and use a two inch hole saw to add two holes side by side for the vent. Add each hole between the four pencil marks etched on the wall from **STEP 83**.  
**PLEASE NOTE:** Only drill half way through the wall to avoid splintering the wood.

85

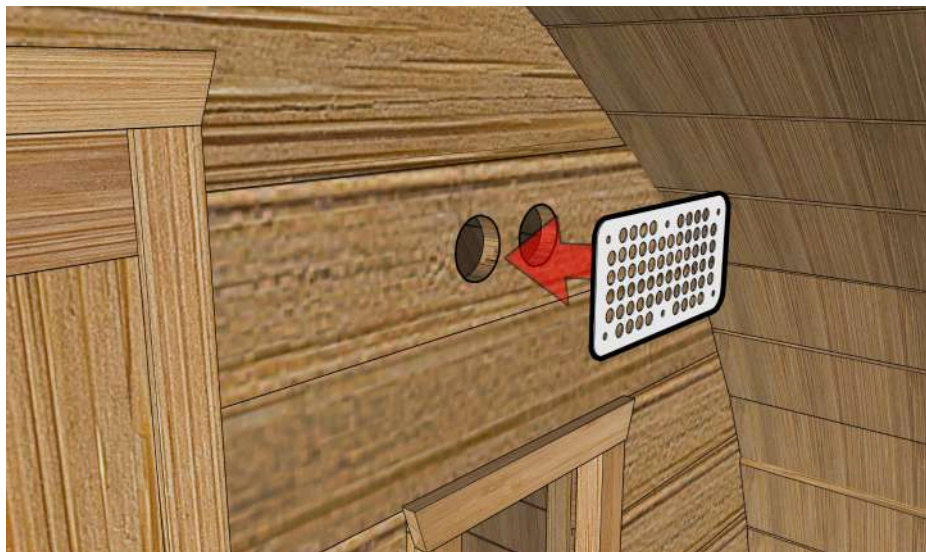

Continue drilling out the holes from the outer wall of the sauna.  
On the outer wall of the sauna position put the vent cover over the two holes.

# VENT installation

86

 **6X**  
Provided screws

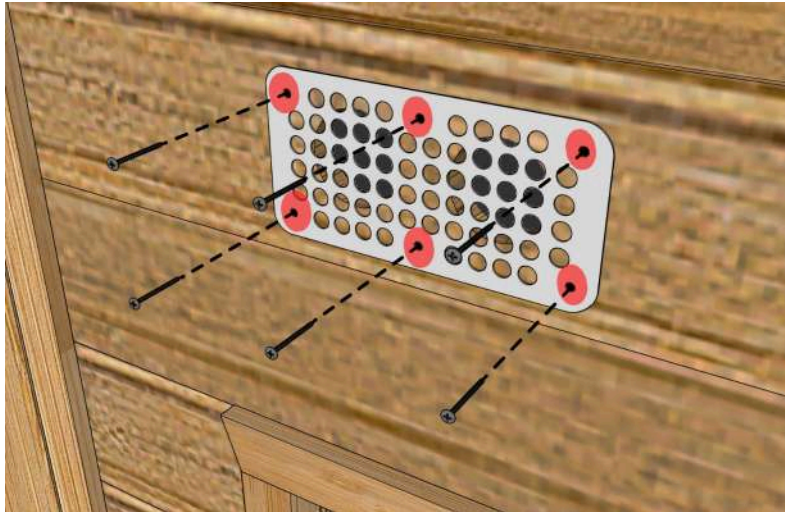
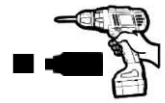

Fasten the vent cover on the outside wall with the six provided screws.

87

 **1X**  
1 1/2" (38 mm) Robertson

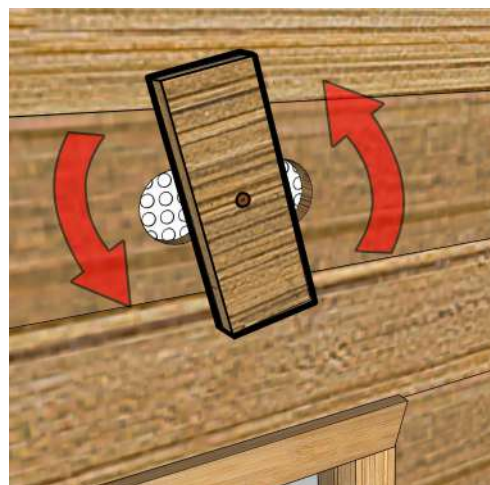
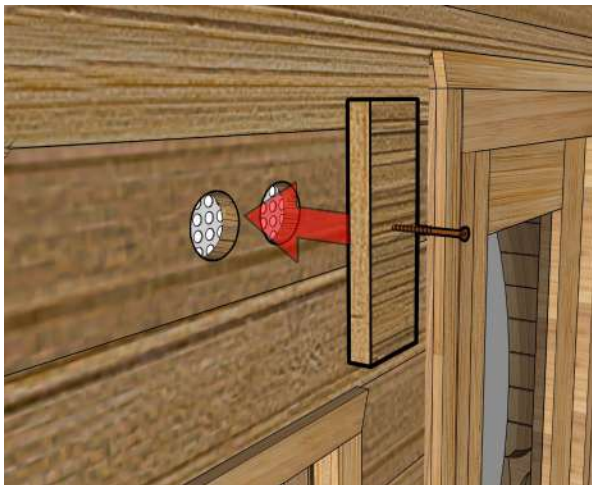
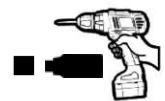

Add a screw to the provided wooden block in the pre-drilled hole.  
Position and fasten the block between the two cut-out holes.

**PLEASE NOTE:** Only tighten the wooden block enough that it may swivel firmly.

## VENT installation

88



Install a second vent under the bench against the back wall using **STEPS 83-86**.

That concludes the instructions for assembling your  
**Canadian Timber Tranquility Sauna.**

If you have any accessories or options left to install or will be in the near  
future please continue on to the next section.

We hope you enjoy your sauna.

## METAL ROOF installation

89

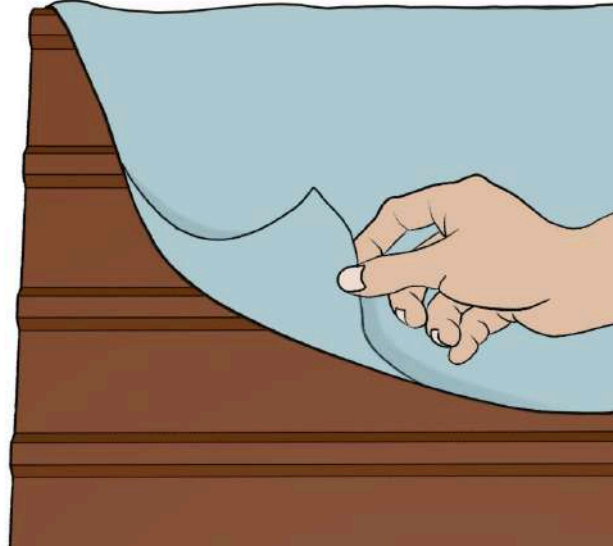

Prepare the metal roofing panels for installation by carefully removing the plastic wrapping and packaging.

90



Place the first two metal roof panels to the top of the sauna.

# METAL ROOF installation

91

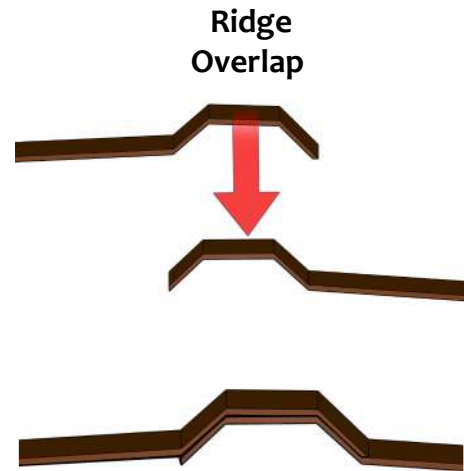

Overlap the last ridge of each of the metal panels together and ensure they are centered on the sauna top.

92



8X

Self Tapping Roof Screws

1/4" (6 mm)

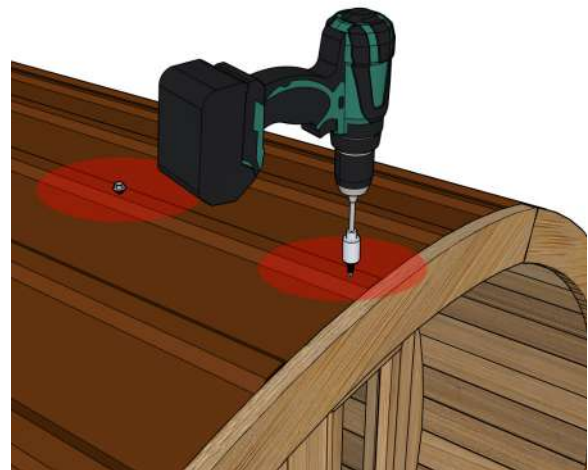

Secure the overlap of both panels with 8 self-sealing roofing screws.

## METAL ROOF installation

93

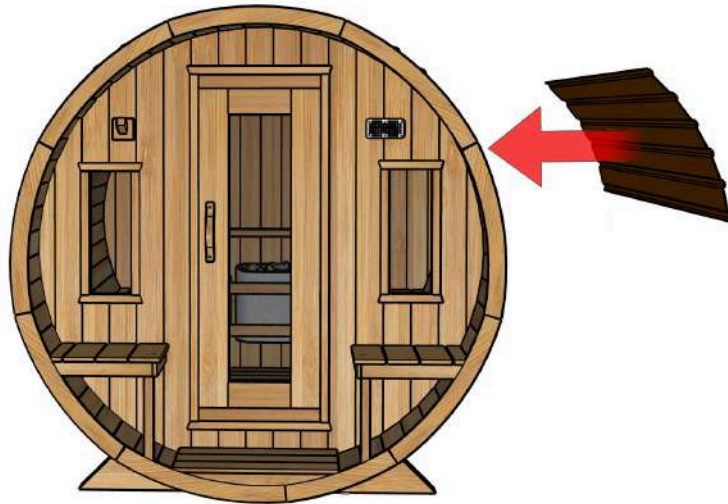

Add one of the side panels.

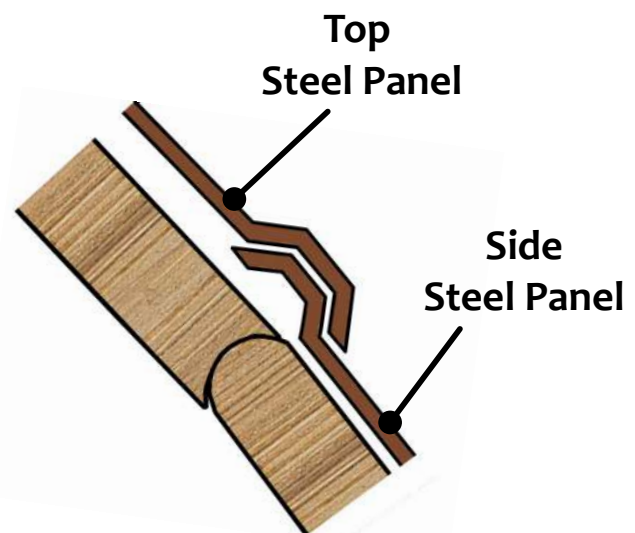

When adding the side steel panels ensure that the top panel ridge overlaps and covers the the side panel ridge (see image above). This will prevent leaking between panels.

## METAL ROOF installation

**94**  **10X**  
Self Tapping Roof Screws

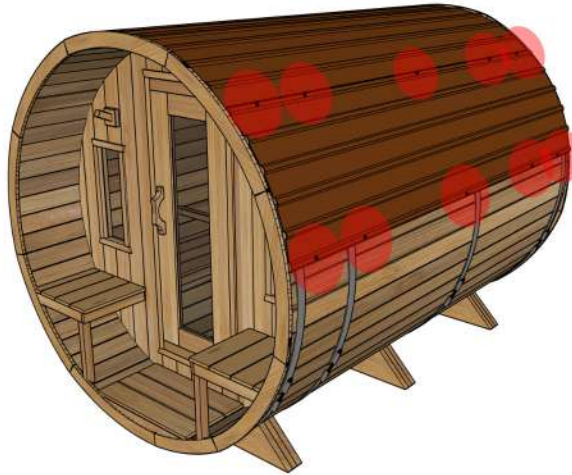
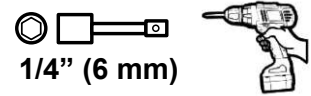

Secure the side panel with 5 self-sealing roofing screws on the top and bottom ridge.

**95**

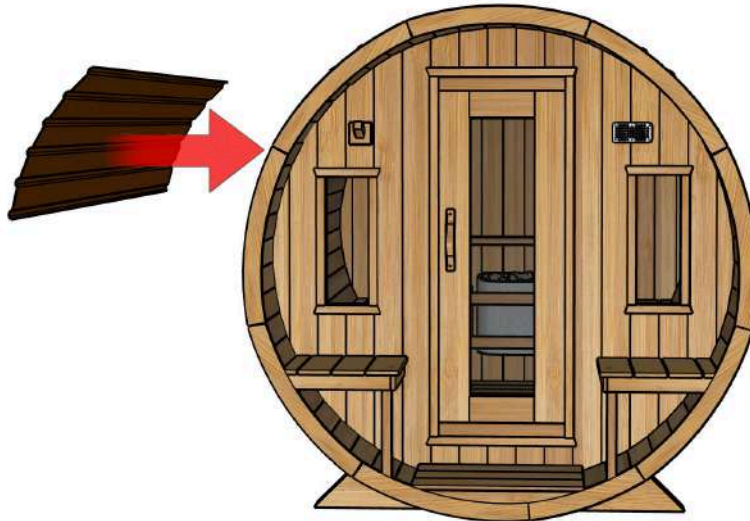

Repeat **STEPS 93-94** for the side panel on the opposite side of the sauna.

## METAL ROOF installation

96

 **1X**  
Self Tapping Roof Screws

  
1/4" (6 mm)

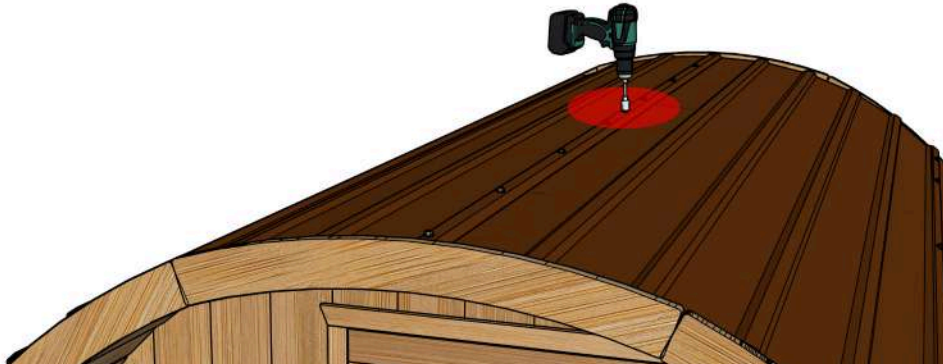

Place a final self-sealing screw into the center of the roof.  
Add more screws into any of the ridges if necessary.

97



The assembly of your metal roof is now complete!  
Watch the metal roof assembly video for more details.



## ACCESSORY install section

98

### Sand Timer (Optional)



1 1/2" (38 mm) Robertson

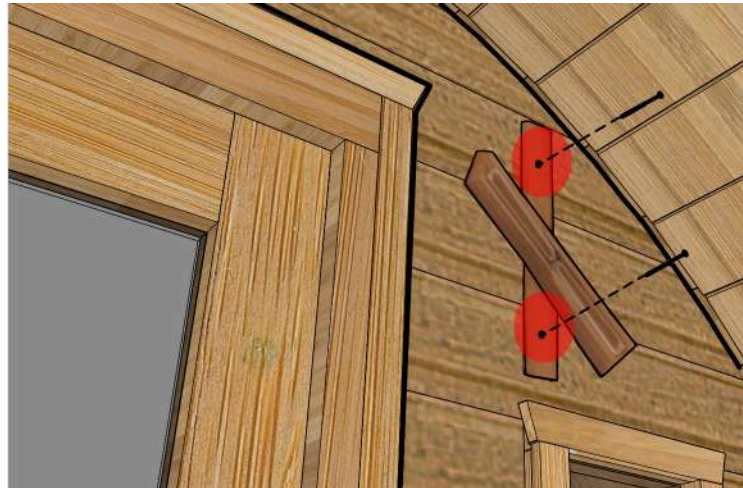
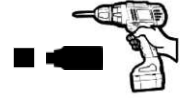

Place the sand timer in the desired location and secure with screws in the pre-drilled holes. Ensure it is in position and level so it may rotate without hitting the wall.

# ACCESSORY install section

## 99 Single Towel Hook

 **4X**  
1 1/2" (38 mm) Robertson

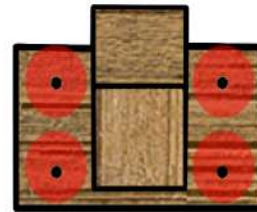
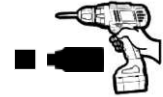

Place the towel hook in desired location and secure with screws in the pre-drilled holes.

## 3 Towel Hook

 **4X**  
1 1/2" (38 mm) Robertson

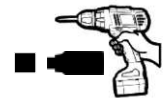

Place the towel hook in desired location and secure with screws in the pre-drilled holes.

# INTRODUCING OUR SAUNA STAINS & FINISHES



## ALIS NATURAL OIL FOR EXTERIOR WOOD

Perfect for your sauna and garden furniture. This protective oil for outdoor wood offers great value.



Sesame



Light Teak



Elm Dark Brown



Black



## MELDOS NATURAL OIL FOR SAUNA INTERIORS

Meldos is a natural and versatile impregnating, perfect for protecting soft Woods and ideal use in saunas.

See your local paint retailer to purchase your preferred outdoor stains or water sealer or you can try LIVOS wood care products from Leisurecraft today!



Scan the code for a video of the assembly process:



# Maintaining Your Sauna After Installation

## INTERIOR

It is recommended to vacuum or sweep out the inside of your sauna frequently to remove dirt and debris. Under normal conditions, a slight wash of the floor and benches with warm soapy water several times a year will maintain its cleanliness. Leisurecraft offers a sauna room cleaner that can be used pure or diluted at a 4-1 ratio. Simply spray and wipe!

You can use a sheet of fine grit sandpaper or a low-pressure wash to remove more stubborn stains for a deeper cleaning of the interior of your sauna.

**NEVER USE ammonia or harsh cleaners as they can turn the wood gray.**



## EXTERIOR

Depending on the humidity and weather conditions in your area, the cedar will either shrink or expand based on the amount of moisture absorption. The desired effect is to have the cedar expand into the bands therefore making the sauna staves much tighter. Over time the lumber will weather naturally as a result of sun and rain, it will change into a weathered grey colour. The natural weathering will not harm the wood or impair the sauna's performance.

If you wish to retain the natural color of your Leisurecraft Sauna, Leisurecraft offers cedar sauna stain in 4 amazing colors, Espresso, Limestone Trail, Onyx Gem, and Pickled White in convenient 1 gallon pails.

## WATER SEEPAGE

Some minor water seeping into the sauna is expected and normal for an outdoor sauna. If your sauna is properly installed, you should not have water dripping in, but you should expect some water seepage, especially on the top and sides of the sauna. This is due to the porous characteristics of the wood and to the ball-and-socket profile design of the staves. Water seepage will not harm the sauna. The moisture will evaporate once you turn on the heater and the sauna heats up. If the water marks are bothersome, they can be easily removed with a light sanding with 80 or 100 grit sandpaper.







## 5 Year Residential Limited Warranty Policy

All products designed and manufactured by Dundalk LeisureCraft Inc. ("LeisureCraft") are covered by a limited warranty against defects in materials and workmanship under normal residential use for a period of five (5) years, beginning on the date the product is received by the original end-user consumer.

This warranty does not apply to defects resulting from normal wear and tear, improper installation, insufficient or improper maintenance, natural weather conditions or failure to follow the manufacturer's installation, usage, or care instructions.

In the event of a valid warranty claim, LeisureCraft will provide replacement parts at no charge. However, please note that the replacement of parts will not extend the original warranty period.

This warranty is limited solely to the replacement of parts and does not cover any associated service, labor, or installation costs, all of which are expressly excluded.

For products offered by LeisureCraft that are not manufactured by LeisureCraft, please refer to the warranty policy and terms provided by the manufacturer.

## LIMITED WARRANTY

Dundalk LeisureCraft Inc. ("LeisureCraft") is committed to providing high-quality sauna heaters and accessories to our customers. To offer peace of mind, we will match the manufacturer's warranty on all eligible products purchased from us. If the manufacturer offers a warranty on the product, we will honor that warranty, ensuring the same terms, coverage, and duration.

This warranty is limited to the replacement of parts only. It does not cover any service, labor, or installation costs, which are expressly excluded.

This warranty does not apply to defects caused by normal wear and tear, improper installation, inadequate or improper maintenance, or failure to adhere to the manufacturer's installation, use, or care instructions.

All electrical connections must be made by a licensed electrician. Failure to comply with this requirement will void the warranty.

For warranty claims or inquiries, please contact LeisureCraft customer support at:

Phone: 888-923-9813 Email: [support@leisurecraft.com](mailto:support@leisurecraft.com)

**Please ensure you fill out your warranty card!**





# Leisurecraft

— BUILDING LUXURY —



pure cübe

318448 8<sup>th</sup> Line Melancton, Ontario  
L9V 2K3 Canada

Phone: 519.923.9813  
Toll Free: 888.923.9813  
Fax: 866.458.7583

Check us on



Info@leisurecraft.com  
www.leisurecraft.com