

Front View

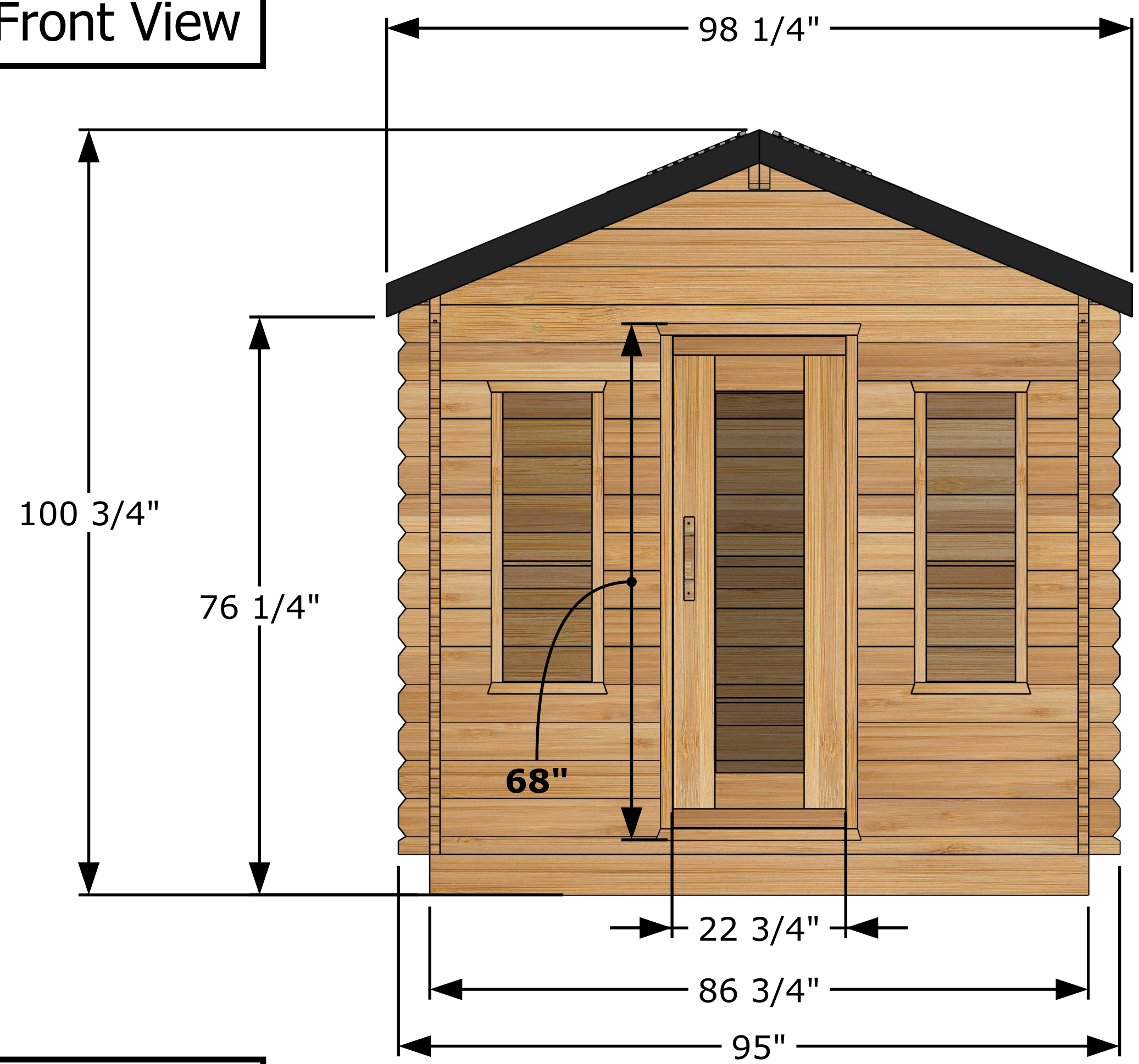

Back View

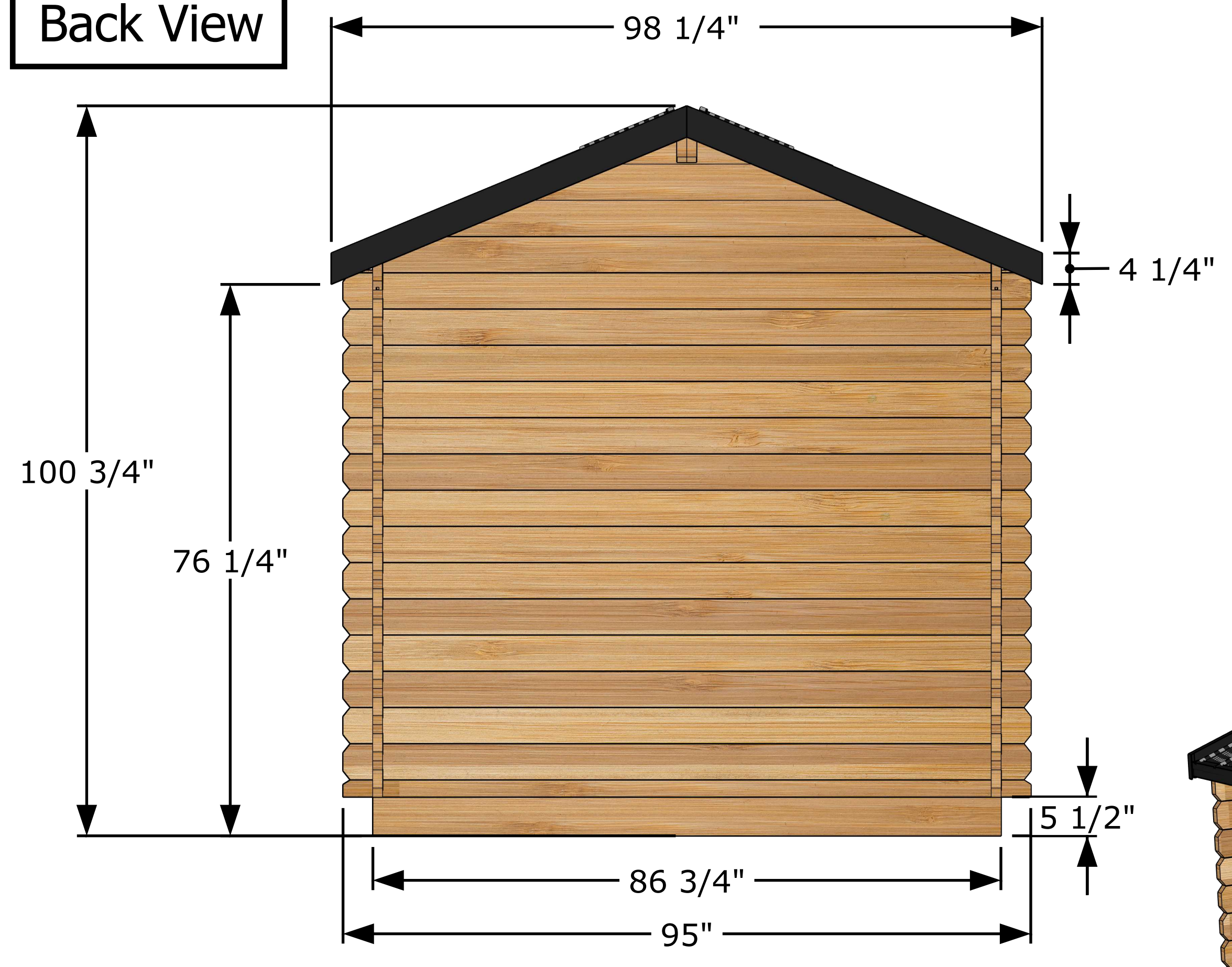

Top View

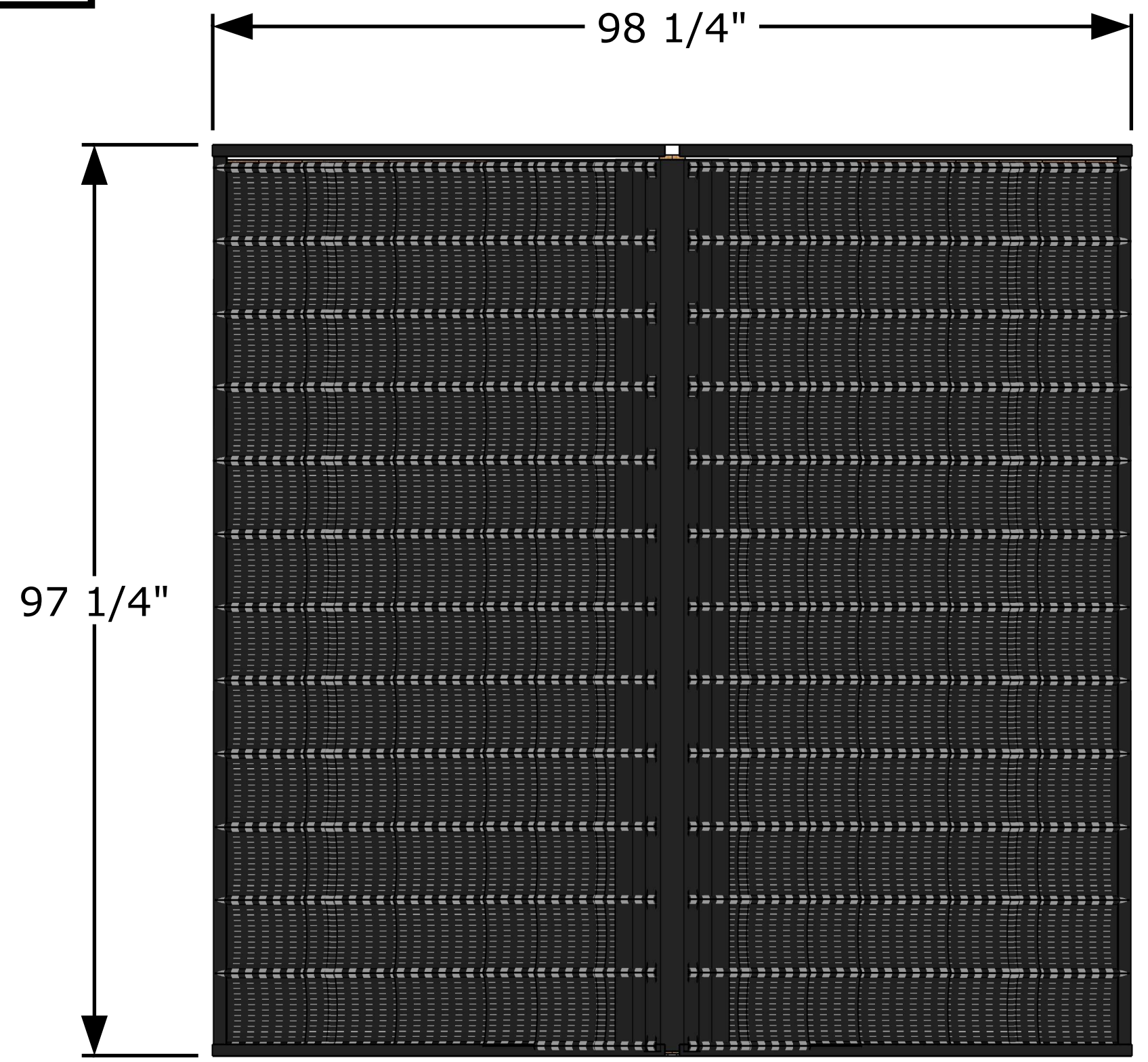

Side View

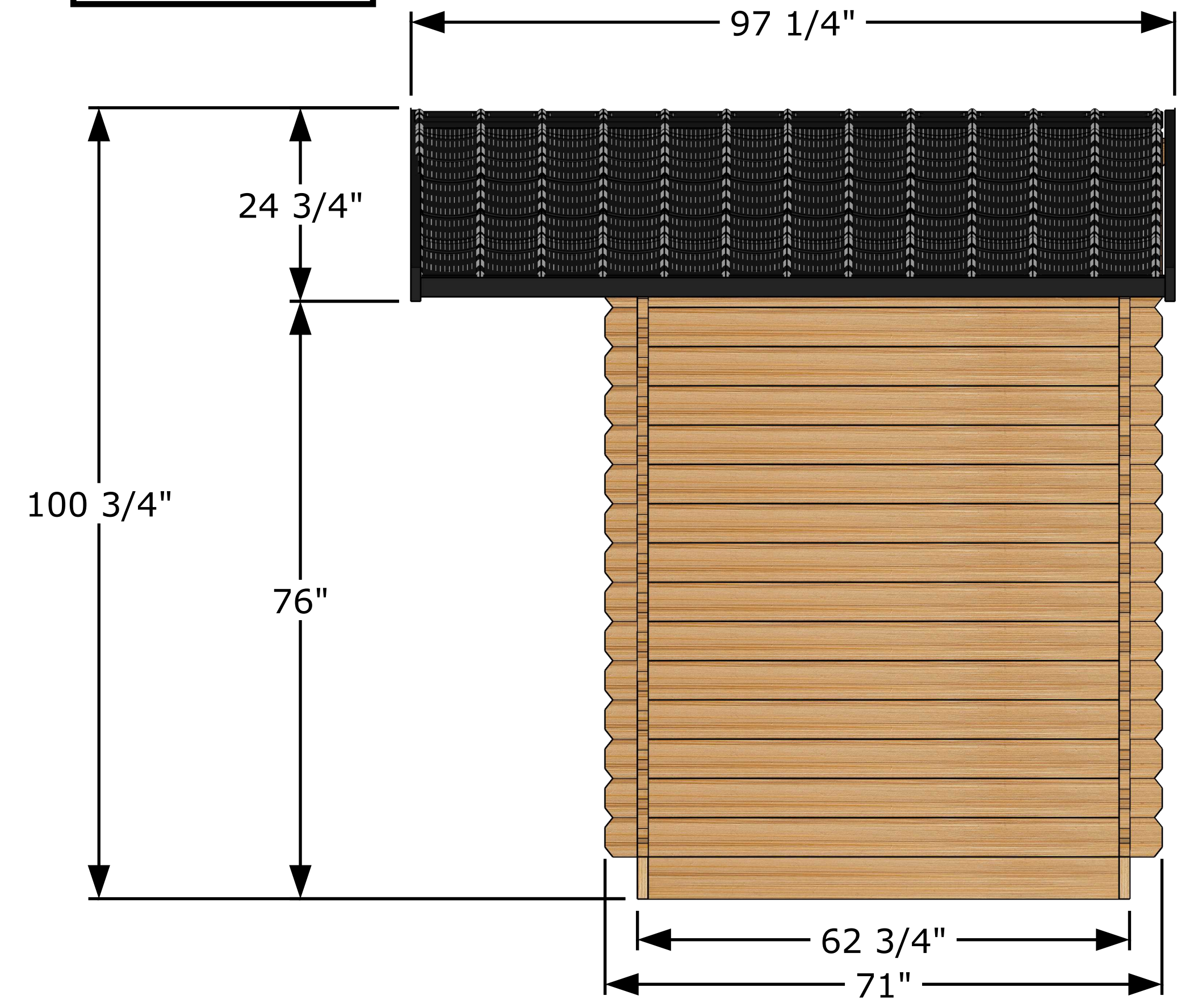

Front View

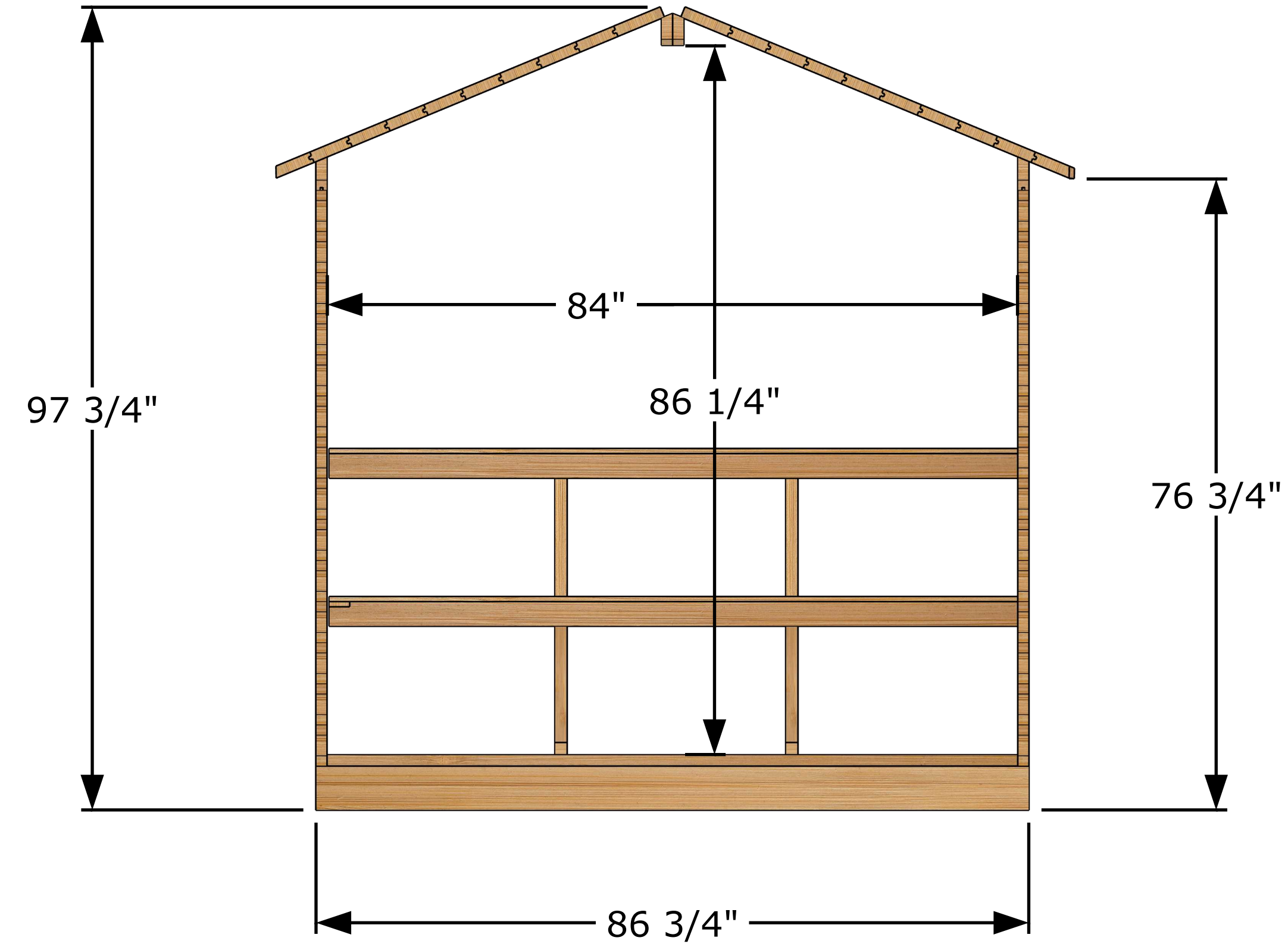

Side View

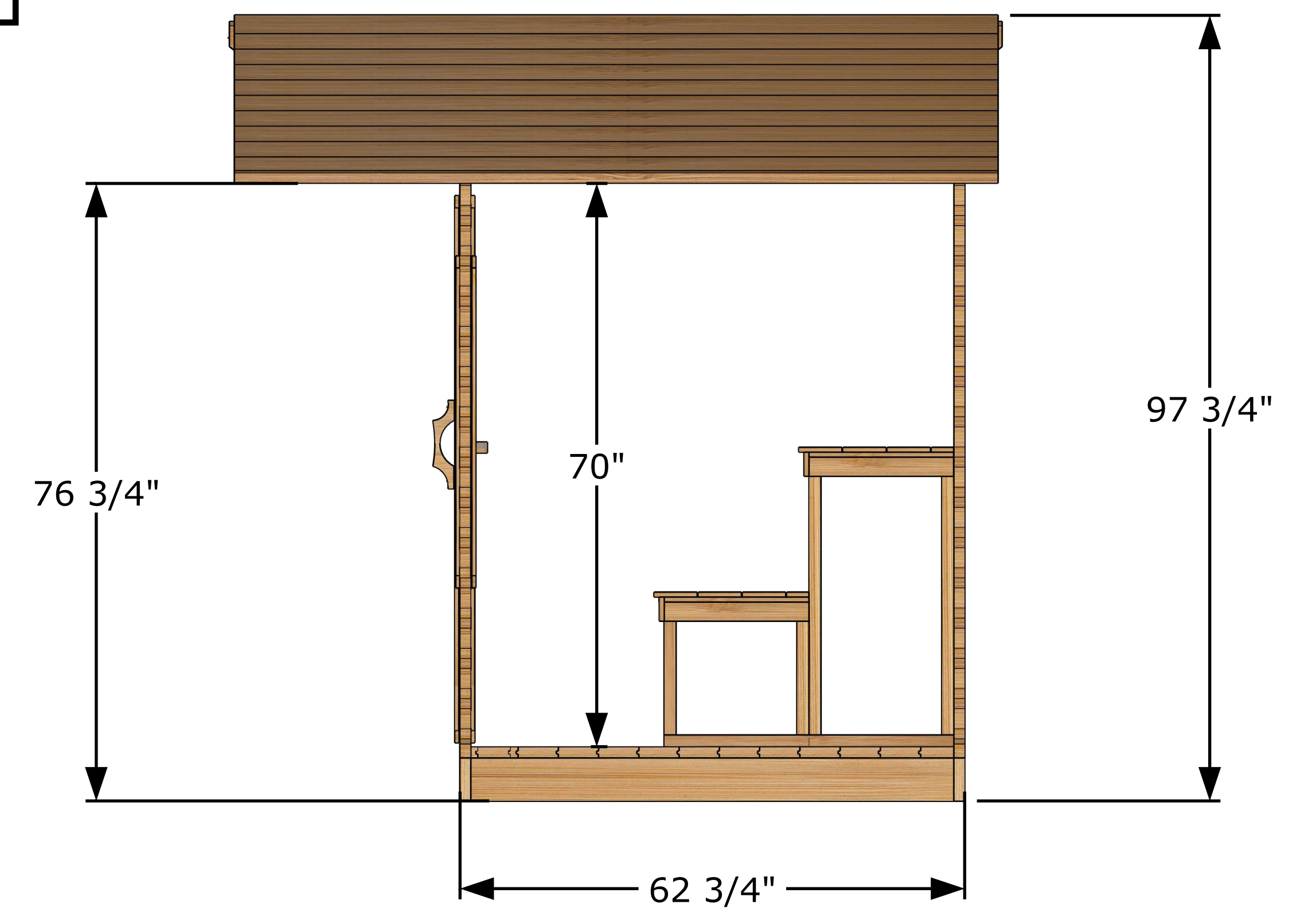

Top View

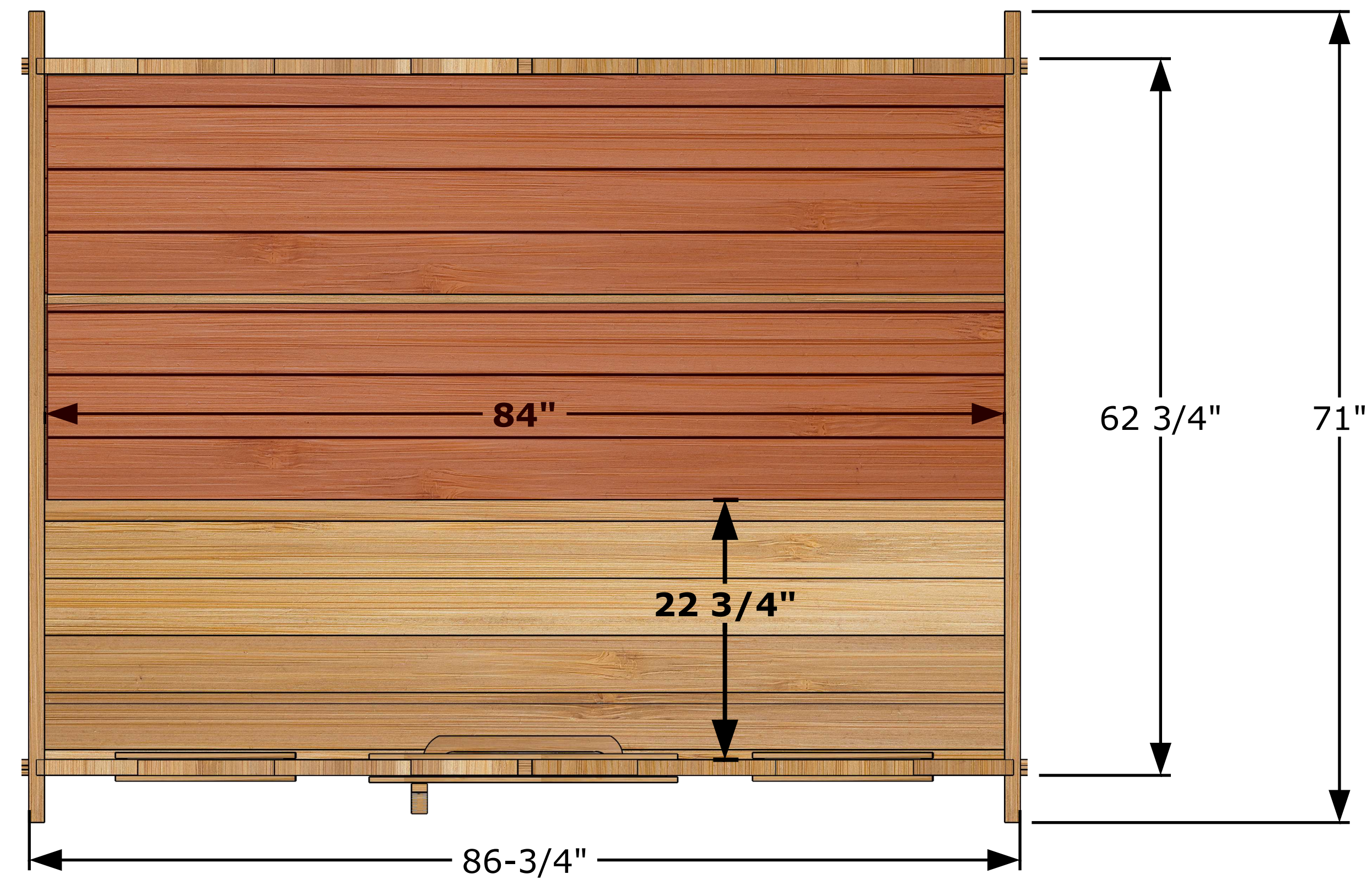

Perspective View

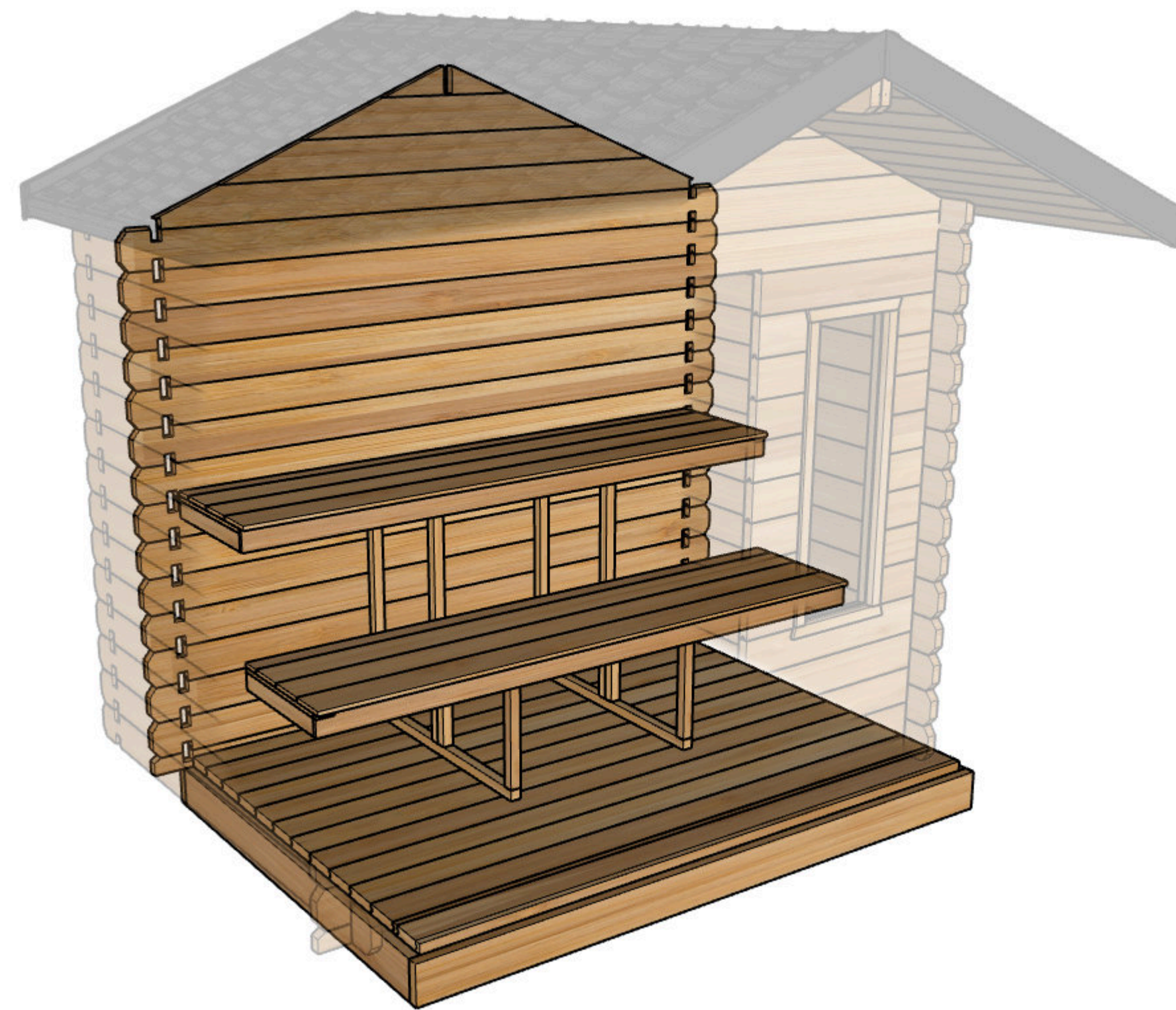

Main Structures and Base Material	Constructed with SPF Eastern White Cedar (softwood structural lumber).
Interior and Ceiling Details	Walls and ceiling T&G Boards Eastern White Cedar wood.
Interior Material	Benches made of Eastern White Cedar wood.
Sauna Door and Windows	Door glass is 5 mm thick tempered glass.
	Window is 5 mm bronze tempered glass.
Door Handle	Door handle made of solid wood, keeping the door closed with a magnet.

Front View

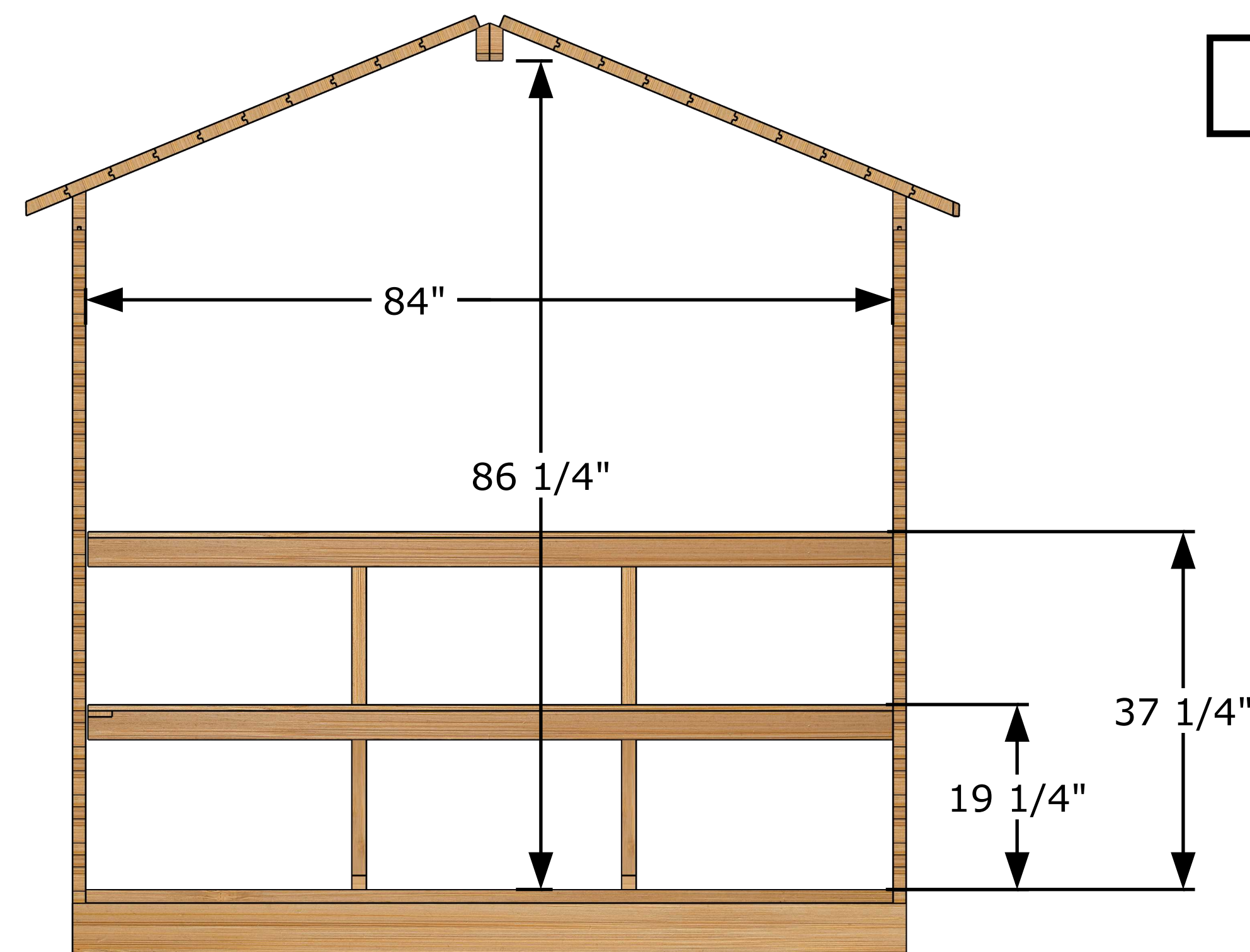

Side View

